

the **1985**  
**ADAM™**  
**Resource**  
**DIRECTORY**

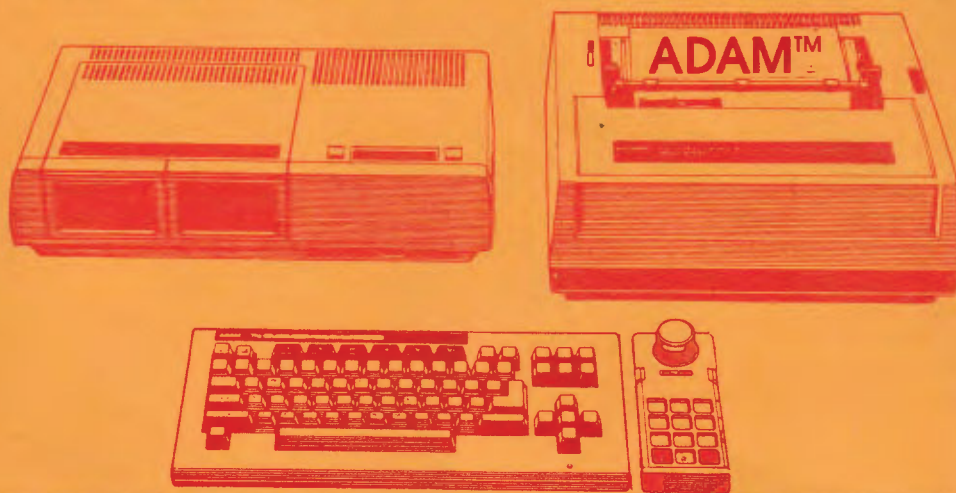

THE DIRECTORY OF SOFTWARE,  
ACCESSORIES, USERS, USER GROUPS,  
**AND MUCH MORE**  
FOR THE ADAM FAMILY COMPUTER OWNER

ADAM™ IS A REGISTERED TRADEMARK OF COLECO INDUSTRIES

the **ADAM**<sup>TM</sup>  
**Resource**  
**DIRECTORY**

**COMPILED**

**&**

**EDITED**

**BY**

**KEITH A BURROWS**

**© COPYRIGHTED 1985 BY**

**THE ADAM RESOURCE**

**P.O. BOX 90  
SEELYVILLE, INDIANA 47878**

**ALL RIGHTS RESERVED.**

NO PART OF THIS PUBLICATION MAY BE REPRODUCED, STORED IN A RETRIEVAL SYSTEM OR TRANSMITTED, IN ANY FORM OR BY ANY MEANS, MECHANICAL, PHOTOCOPYING, RECORDING OR OTHERWISE, WITHOUT PRIOR WRITTEN PERMISSION OF THE ADAM RESOURCE.

NO LIABILITY IS ASSUMED WITH RESPECT TO THE USE OF THE INFORMATION CONTAINED HEREIN. WHILE EVERY PRECAUTION HAS BEEN TAKEN IN THE PREPARATION OF THIS DIRECTORY, THE ADAM RESOURCE AND THE EDITOR ASSUME NO RESPONSIBILITY FOR ERRORS OR OMISSIONS. NEITHER IS ANY LIABILITY ASSUMED FOR DAMAGES RESULTING FROM THE USE OF THE INFORMATION CONTAINED HEREIN.

THIS DIRECTORY IS INTENDED FOR THE USE OF THE OWNER. IT IS ILLEGAL, DISHONEST, AND THREATENING TO THE LIFE OF THE ADAM COMPUTER SYSTEM, IF YOU COPY IT FOR ANYBODY! KEEP THIS PUBLICATION AND THE ADAM COMPUTER SYSTEM ALIVE BY TELLING YOUR FRIENDS TO PURCHASE THEIR OWN DIRECTORY.

# WELCOME TO the **ADAM**<sup>TM</sup> Resource

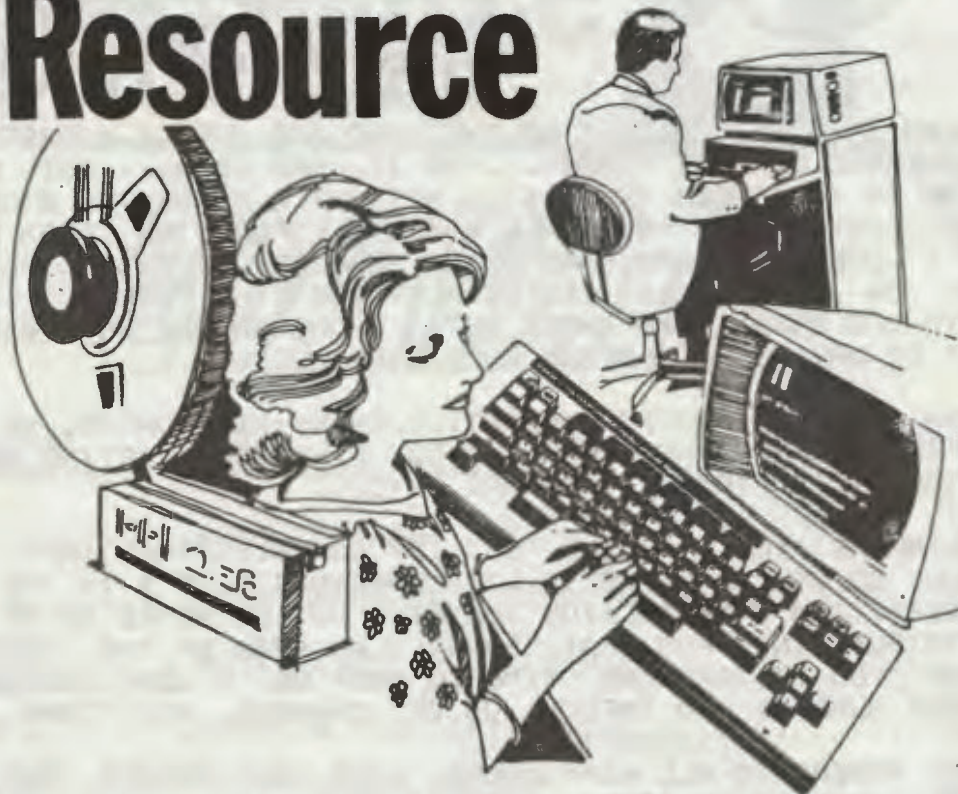

YOU HAVE JUST PURCHASED (AT LEAST I HOPE YOU DID) THE MOST COMPLETE LISTING OF RESOURCE MATERIAL FOR THE ADAM FAMILY COMPUTER SYSTEM THAT IS AVAILABLE.

THIS DIRECTORY HAS BEEN MONTHS IN THE MAKING. WE HAVE WRITTEN LITERALLY HUNDREDS OF LETTERS TO GROUPS & RETAILERS COLLECTING INFO SO THAT YOU CAN HAVE IT ALL AT THE CONVENIENCE OF YOUR FINGERTIPS.

IT IS OUR SINCERE HOPE THAT THIS DIRECTORY WILL HELP YOU PERSONALLY TO GET THE MOST OUT OF THE ADAM AS WELL AS HELP TO PUT YOU IN CONTACT WITH THE REST OF THE "ADAM WORLD".

YOU ARE ONE OF 400,000 LUCKY PEOPLE TO HAVE AN ADAM AND OUR GOAL IS TO MAKE YOU AWARE OF EVERYTHING THAT'S AVAILABLE FOR THIS UNIQUE SYSTEM.

ALTHOUGH COLECO IS NO LONGER MAKING THE ADAM, MANY 3RD PARTY PRODUCERS ARE COMING TO THE RESCUE. LET'S SUPPORT THESE PEOPLE AND SUPPORT FOR THE ADAM WILL CONTINUE FOR A LONG TIME!

THE ADAM RESOURCE DIRECTORY WILL BE PUBLISHED TWICE A YEAR (FALL, SPRING) SO DON'T MISS THE NEXT EDITION FOR ALL THE LATEST. WE HOPE THIS DIRECTORY WILL BE SOMETHING YOU REFER TO QUITE FREQUENTLY, AND THAT IT PROVIDES A VERY MUCH NEEDED SERVICE TO YOU AND ALL ADAM OWNERS.



# Just a note... FROM **THE EDITOR**

AS YOU CAN IMAGINE, COLLECTING THE INFO FOR SUCH A PROJECT CAN BE QUITE OVERWHELMING AT TIMES...AND IT HAS BEEN....BUT WHAT YOU WILL FIND IN THE PAGES TO COME IS WITHOUT A DOUBT THE SINGLE MOST COMPLETE LISTING OF RESOURCE MATERIAL FOR THE ADAM COMPUTER SYSTEM. I LOVE THE ADAM, AND STILL BELIEVE IT IS THE BEST HOME COMPUTER ON THE MARKET (ESPECIALLY FOR THE MONEY). IT IS MY DESIRE TO SEE EVERY ADAM OWNER GET A THOROUGH USE OF THEIR SYSTEM AND THAT IS WHY WE HAVE BEGUN SUCH A PROJECT....

...BUT THIS IS AN ONGOING PROJECT....EVERY SIX MONTHS, WE PLAN TO PUBLISH AN ENTIRELY NEW AND UPDATED DIRECTORY LISTING NEW USER GROUPS, USERS, SOFTWARE, HARDWARE, ETC...

THIS IS WHERE YOU CAN HELP US...BY CONTRIBUTING INFO THAT YOU KNOW ABOUT SO WE CAN SHARE IT WITH EVERYONE ELSE & IN THE END WE ALL BENEFIT! IN EACH SECTION YOU WILL NOTICE NOTES AS TO HOW YOU CAN CONTRIBUTE INFO FOR THAT PARTICULAR AREA OF THE DIRECTORY. I ENCOURAGE YOU TO TAKE THE TIME TO DROP US A LINE (USING PROPER DEPARTMENT NUMBER) TO INFORM US OF CHANGES, ADDITIONS, ETC...

I MAKE AN APPEAL TO ALL ADAM USERS, ADAM USER GROUPS, AND PRODUCT PRODUCERS TO SEND US YOUR LATEST INFO & WE'LL PASS IT ALONG IN FUTURE EDITIONS. FOR EXAMPLE....USER GROUPS.....IN THE NEXT EDITION WE WILL HAVE A USER GROUP NEWS SECTION. IF YOU WILL PUT US ON YOUR MAILING LIST & SEND US YOUR NEWSLETTER, WE'LL LET OTHER GROUPS KNOW WHAT YOU ARE DOING.

ALSO IN OUR NEXT EDITION WE WILL HAVE A REVIEW SECTION FOR NEW SOFTWARE & HARDWARE. IF YOU ARE A RETAILER, OR PRODUCER, WE ENCOURAGE YOU TO SEND US A COPY OF YOUR LATEST PRODUCTS AND WE WILL INCLUDE IT IN OUR REVIEW SECTION (MAKING SPECIAL NOTE OF YOUR PROVISION). (NOTE: IF YOU REQUEST SUCH, WE WILL RETURN YOUR COPY AFTER A REASONABLE AMOUNT OF TIME FOR REVIEW)

LET'S ALL GET TOGETHER AND MAKE IT HAPPEN!!!!THE MORE COOPERATION WE HAVE WITH EVERYBODY, A HIGHER "QUALITY" OF PRODUCT CAN BE DELIVERED TO YOU!

I WANT TO MAKE A SPECIAL NOTE OF THANKS TO MY WIFE, CHERYL. SHE'S THE ONE WHO GAVE ME THE IDEA FOR SUCH A PUBLICATION AS THIS AND SHE'S THE ONE THAT HAD TO PUT UP WITH ME DURING ALL THOSE HOURS OF WORK. THANKS HONEY! I LOVE YOU!

KEITH A. BURROWS

# the ADAM<sup>TM</sup> Resource

P.O. BOX 90  
SEELYVILLE, INDIANA 47878



## CONTENTS:

| SECTION     | TITLE                                | PAGE  |
|-------------|--------------------------------------|-------|
| *****       | *****                                | ***** |
| ONE.....    | ADAM SOFTWARE LISTINGS.....          | 4     |
| TWO.....    | ADAM HARDWARE & ACCESSORIES.....     | 21    |
| THREE.....  | RETAILERS (MAIL-ORDER CO).....       | 25    |
| FOUR.....   | BOOKS & PUBLICATIONS.....            | 30    |
| FIVE.....   | USER GROUP LISTINGS.....             | 33    |
| SIX.....    | ADAM USER LISTINGS (INDIVIDUAL)..... | 37    |
| SEVEN.....  | SERVICE INFORMATION.....             | 46    |
| EIGHT.....  | TIP-SECTION.....                     | 49    |
| NINE.....   | AD-SECTION (RETAILER'S ADS).....     | 54    |
| TEN.....    | FREWARE & PUBLIC DOMAIN SOURCES..... | 66    |
| ELEVEN..... | ONLINE INFORMATION (BBS'S).....      | 68    |

EDITOR'S NOTE: ALL SOFTWARE AND HARDWARE LISTED IN THIS DIRECTORY IS LISTED BY ITS MANUFACTURER'S NAME. THESE NAMES HAVE BEEN LISTED FOR REFERENCE PURPOSES ONLY AND NO COPYRIGHT INFRINGEMENT IS INTENDED WHEN LISTING TRADEMARK NAMES.

# the ADAM™ Resource

P.O. BOX 90  
SEELYVILLE, INDIANA 47878



## SECTION ONE (#1)

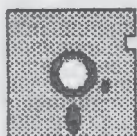

# SOFTWARE

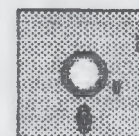

IN THIS SECTION YOU WILL FIND THREE SOFTWARE LISTINGS AS FOLLOWS:

**1. COMPLETE ALPHABETICAL LISTING (MASTER)**

THIS LISTING INCLUDES-TITLE,CATEGORY, MANUFACTURER,FORMATS AVAILABLE,AVERAGE PRICE,& A BRIEF DESCRIPTION OF THE PRODUCT.

**2. SOFTWARE BY CATEGORY**

ALL SOFTWARE IS LISTED BY CATEGORY. EACH PIECE OF SOFTWARE HAS BEEN ASSIGNED TO A CATEGORY IN WHICH IT WOULD MOST LIKELY BE USED THIS LISTING ONLY LISTS TITLES. (REFER TO THE "MASTER LISTING" FOR THE DETAILS.

**3. CARTRIDGE SOFTWARE**

A LISTING OF CARTRIDGES AVAILABLE FOR ADAM & COLECOVISION.

THE FOLLOWING ABBREVIATIONS HAVE BEEN USED IN THIS SECTION:

|                     |                         |
|---------------------|-------------------------|
| D - DISK            | ENT - ENTERTAINMENT     |
| C - CARTRIDGE       | UTI - UTILITY           |
| T - DATAPACK (TAPE) | HOM - HOME APPLICATIONS |
| MUS - MUSIC         | GRA - GRAPHICS          |
| FIN - FINANCES      | CPM - CPM               |
| BUS - BUSINESS      |                         |
| EDU - EDUCATIONAL   |                         |

**ATTENTION RETAILERS:**

KEEP THE ADAM RESOURCE INFORMED OF NEW ADDITIONS TO YOUR LINE OF PRODUCTS & WE WILL INCLUDE THEM IN FUTURE EDITIONS.

SEND YOUR LATEST LISTINGS & CATALOGS TO:

THE ADAM RESOURCE  
DEPT. 10 BOX 90  
SEELYVILLE, IN 47878

**1.COMPOSITE  
ALPHABETICAL  
SOFTWARE LISTING  
(MASTER LISTING)**

\*\*\*\*32 BASIC PROGRAMS\*\*\*\*ENT-T-DILITHIUM PRESS-24.95(BOOK INCLUDED)

\*\*\*\*ABC's\*\*\*\*EDU-DT-CME Software-14.95(Interactive,ages 2-6)

\*\*\*\*ACCESS MANAGER-80\*\*\*\*CPM-D-Westico-219.5(\$219.95  
Development tool)

\*\*\*\*ADAM CALC\*\*\*\*BUS-T-COLECO-34.95()

\*\*\*\*ADAM FILER\*\*\*\*BUS-T-ADAM WORLD ENTERPRIS-19.95()

\*\*\*\*ADAM'S RIB\*\*\*\*-T-TAPEWARE TECHNOLOGY-32.95()

\*\*\*\*ADAVENTURE PACK 1\*\*\*\*ENT-DT-VICTORY SOFTWARE-20.95(3- text programs: Moon  
Base Alpha, Jack & the Beanstalk, Computer Adventure.)

\*\*\*\*ADDRESS BOOK & AUTODIALR\*\*\*\*HOM-T-COLECO-34.95(INCLUDES AUTODIALER)

\*\*\*\*ADDRESS FILE\*\*\*\*MIS-T-Micro 2-24.95(address/phone info)

\*\*\*\*ADDRESS LABELS\*\*\*\*MIS-DT-Kray Software-17.00(listing only:\$7.00)

\*\*\*\*ADDRESS LABELS\*\*\*\*HOM-TDL-KRAY-7.00(PRICE IS FOR A LISTING. ADD ONE TIME  
CHARGE OF \$10.00 PER PROGRAM(S) ORDER FOR EITHER TAPE OR DISK.)

\*\*\*\*ADVENTURE PACK\*\*\*\*ENT-T-INCO-19.95()

\*\*\*\*ADVENTURE PACK 2\*\*\*\*ENT-DT-VICTORY SOFTWARE-20.56(3 text programs:African  
Adventure, Hospital Adventure, Bomb Threat.)

\*\*\*\*ANALYSIS\*\*\*\*BUS-DT-Kray Software-20.00(listing only:\$10.00 line & bar  
graphs,percentage analysis.)

\*\*\*\*ANALYSIS\*\*\*\*BUS-TDL-KRAY-10.00(PRICE IS FOR A LISTING. ADD ONE TIME CHARGE  
OF \$10.00 PER PROGRAM(S) ORDER FOR EITHER TAPE OR DISK.  
Displays bar and line graphs.)

\*\*\*\*APPIAN WAY\*\*\*\*ENT-T-Challenge Ware-19.95(Need LOGO.Keep your chariot on  
the road to adventure!)

\*\*\*\*ARTISTS PAD\*\*\*\*GRA-T-Nickelodeon Graphics-25.00()

\*\*\*\*ASCOM\*\*\*\*CPM-D-Westico-139.9(Telecommunication software. \$109.95)

\*\*\*\*AWARDS & CERTS\*\*\*\*MIS-DT-CME Software-19.95(Prints awards & certificates.)

# \*\*SOFTWARE\*\*

\*\*\*\*B-DESK DESKMASTER\*\*\*\*BUS-T-Nickelodeon Graphics-19.95(card files,address list,telephone list,record of sale & purchases etc...)

\*\*\*\*BASIC GAME LIBRARY\*\*\*\*ENT-T-DAVASAN SOFTWARE-39.95(RUSSIAN ROULETTE CHECKERS GOLF POKER COMPUTER STORIES BOWLING ETC.)

\*\*\*\*BDS C\*\*\*\*CPM-D-Westico-109.9(\$109.95 Language Processor)

\*\*\*\*BEST ELECTRONIC WORDGAME\*\*\*\*ENT-T-COLECO-29.95()

\*\*\*\*BEST OF BRODERBUND\*\*\*\*ENT-T-COLECO-29.95(2 games- CHOPLIFTER AND AE)

\*\*\*\*BEST OF ELECTRONIC ARTS\*\*\*\*ENT-T-COLECO-29.95(2 games- HARD HAT MACK AND PINBALL CONSTRUCTION)

\*\*\*\*BESTO OF SIERRA\*\*\*\*ENT-T-COLECO-29.95(2 games- JAW BREAKER ANDTROLL'S TALE)

\*\*\*\*BLACK GOLD\*\*\*\*ENT-DT-IMAGE MICROCORP-24.95(Board style game.Find the hidden oil deposit.)

\*\*\*\*BOND AMORT\*\*\*\*BUS-DT-CME Software-14.95()

\*\*\*\*BOUNTY HUNTER\*\*\*\*ENT-DT-VICTORY SOFTWARE-20.95(Full length text adventure. You play the role of a bounty hunter.)

\*\*\*\*BPSxref\*\*\*\*CPM-D-Westico-89.95(Development tool)

\*\*\*\*BRAIN STRAINERS\*\*\*\*EDU-C-COLECO-22.95(Musical note recognition,pattern recognition,auditory discrimination.)

\*\*\*\*BUSINESS BONUS PACK\*\*\*\*BUS-T-MICRO 2-32.95(INCLUDES: PROPERTY MANAGER, CASH FLOW ANALYSIS, STOCK PROFILES, INVESTMENT ANALYSIS, & ADDRESS FILE)

\*\*\*\*BUSINESS GRAPHS PAK\*\*\*\*BUS-T-Nickelodeon Graphics-29.00(Plot data in 6 styles.)

\*\*\*\*BUYSEL\*\*\*\*CPM-D-Westico-109.9(\$109.95 Planning & Analysis)

\*\*\*\*C PROGRAMMING LANGUAGE\*\*\*\*CPM-D-Westico-17.95(Language Processor)

\*\*\*\*CAMPAIGN '84\*\*\*\*ENT-T-SUNRISE SOFTWARE-14.95()

\*\*\*\*CASH FLOW ANALYSIS\*\*\*\*FIN-T-Micro 2-24.95(pictures business cash flow.)

\*\*\*\*CASTLE OF DOOM\*\*\*\*ENT-T-Challenge Ware-19.95(Medieval adventure.)

\*\*\*\*CB-80\*\*\*\*CPM-D-Westico-369.9(\$369.95 Language processor)

\*\*\*\*CBASIC-80\*\*\*\*CPM-D-Westico- (\$109.95)



# **\*\*SOFTWARE\*\***

- \*\*\*\*CONDOR 20-1\*\*\*\*CPM-D-Westico- (Data Management. \$219.95)
- \*\*\*\*CONVERT\*\*\*\*UTI-D-Unreal Software-34.95(Allows you to copy non- ADAM CP/M disks to ADAM format.)
- \*\*\*\*COUNTING\*\*\*\*EDU-DT-CME Software-14.95(Interactive, ages 2-6)
- \*\*\*\*CP/M 2.2 & ASSEMBLER\*\*\*\*UTI-T-COLECO-59.95()
- \*\*\*\*CP/M WORKSHOP\*\*\*\*CPM-D-Westico-79.95()
- \*\*\*\*CREDIT CARD FILE\*\*\*\*FIN-T-Micro 2-24.95()
- \*\*\*\*CUE CARDS\*\*\*\*UTI-T-STEVE JACOBY-9.95(A DECK OF 99 CUE CARDS WITH ALL OF THE BASIC COMMANDS- PEEKS, POKES, AND CALLS. GOOD LEARNINGAID FOR BEGINNERS AND QUICK REFERENCE FOR EXPERIENCED PROGRAMMERS.)
- \*\*\*\*DATA CALC\*\*\*\*BUS-T-ADAM WORLD ENTERPRIS-19.95()
- \*\*\*\*DATA FILER\*\*\*\*BUS-T-DATA BACKUP-6.95()
- \*\*\*\*DATA CALC\*\*\*\*BUS-DT-Strategic Software-24.95(Spreadsheet)
- \*\*\*\*DATAKEEPER\*\*\*\*BUS-T-Challenge Ware-19.95(A versatile data base.)
- \*\*\*\*DATEBOOK II\*\*\*\*CPM-D-Westico- (Price is \$219.95)
- \*\*\*\*DAWN\*\*\*\*BUS-T-MAGIC WAND ENTERPRIS-29.95(DATA BASE PROGRAM)
- \*\*\*\*DBASE II\*\*\*\*CPM-D-Westico- (Data Management. \$369.95)
- \*\*\*\*DGRAPH\*\*\*\*CPM-D-Westico- (\$219.95 Planning & Analysis)
- \*\*\*\*DIABLO\*\*\*\*ENT-DT-IMAGE MICROCORP-24.95(Excellent graphric game. Utilizes ADAM's graphics to the maximum.)
- \*\*\*\*DISASSEMBLER\*\*\*\*UTI-DT-IMAGE MICROCORP-24.95(Converts machine code into something readable. Must have knowledge of machine language to use.)
- \*\*\*\*DISK TRANSFER SERVICE\*\*\*\*CPM-D-Westico-17.95()
- \*\*\*\*DISPLAY MANAGER-80\*\*\*\*CPM-D-Westico- (\$299.95 Development tool)
- \*\*\*\*DONKEY KONG\*\*\*\*ENT-T-COLECO-29.95()
- \*\*\*\*DONKEY KONG JR\*\*\*\*ENT-T-COLECO-29.95()
- \*\*\*\*DR ASSEMBLER & TOOLS\*\*\*\*CPM-D-Westico- (\$149.95)

# \*\*SOFTWARE\*\*

- \*\*\*\*DRAGON'S CAVERN\*\*\*\*ENT-T-Challenge Ware-19.95(Fantasy graphics game.)
- \*\*\*\*DRAGON'S LAIR\*\*\*\*ENT-T-COLECO-29.95()
- \*\*\*\*duTIL\*\*\*\*CPM-D-Westico-69.95(Development tool)
- \*\*\*\*EARN-SAVE HISTORY\*\*\*\*FIN-DT-Kray Software-20.00(listing only:\$10.00 personal income & savings records.)
- \*\*\*\*EARN-SAVE HISTORY\*\*\*\*HOM-TDL-KRAY-10.00(PRICE IS FOR A LISTING. ADD ONE TIME CHARGE OF \$10.00 PER PROGRAM(S) ORDER FOR EITHER TAPE ORDISK. Keeps track of income and savings for 2 people)
- \*\*\*\*EASYPERT\*\*\*\*BUS-DT-CME Software-19.95(A project management pak that uses activity-on-arrow method.)
- \*\*\*\*EDUCATION\*\*\*\*EDU-T-Steve Jacoby Co.-19.95(7 programs)
- \*\*\*\*EDUCATION BONUS PACK\*\*\*\*EDU-T-MICRO 2-32.95(INCLUDES: MICRO MATH SERIES, READING FUN, MAKING CHANGE, & VOCABULARY BUILDERS)
- \*\*\*\*EDUCATION II LIBRARY\*\*\*\*ENT-T-DAVASAN SOFTWARE-39.95(15 programs CHEMIST STOCKMARKET POETRY WORD SAFARI PARACHUTE ETC.)
- \*\*\*\*EDUCATION LIBRARY\*\*\*\*EDU-T-DAVASAN-39.95(15 programs 3-D plotter monster speller Math Dice Trivia Quiz etc.)
- \*\*\*\*EDUCATIONAL PROGRAMS\*\*\*\*EDU-T-DATA BACKUP-6.95()
- \*\*\*\*ELECTRONIC CIRCUIT ANAL\*\*\*\*CPM-D-Westico- (ELECTRONIC CIRCUIT ANALYSIS. \$109.95)
- \*\*\*\*ELECTRONIC FLASHCARD MKR\*\*\*\*EDU-T-COLECO-19.95(make flashcards or use pre-made decks.)
- \*\*\*\*EUROCAPITALS\*\*\*\*EDU-DT-CME Software-14.95()
- \*\*\*\*EXPERTYPE\*\*\*\*EDU-T-COLECO-34.95()
- \*\*\*\*EXTENDED BASIC UTILITIES\*\*\*\*UTI-T-EXTENDED SOFTWARE-19.95()
- \*\*\*\*F-DESK MASTER\*\*\*\*BUS-T-Nickelodeon Graphics-19.95(create your own desk files.)
- \*\*\*\*FAMILY ACCOUNTING\*\*\*\*HOM-T-DAVASAN SOFTWARE-39.95(FINANCES, FAMILY BUDGET AND ACCOUNTING)
- \*\*\*\*FAMILY FEUD\*\*\*\*ENT-T-COLECO-29.95()

## **\*\*SOFTWARE\*\***

- \*\*\*\*FANTASY GAMER\*\*\*\*ENT-T-Martin Consulting-34.95(3-programs, THE VISITOR, BOMB SQUAD, ADVENTURE CREATOR. Create your own adventure games using this program.)
- \*\*\*\*FASTFILER\*\*\*\*BUS-TD-Strategic Software-24.95(Smartfiler type program)
- \*\*\*\*FLASH FACTS:FLASH BACKS\*\*\*\*EDU-T-COLECO-13.95()
- \*\*\*\*FLASH FACTS:TRIVIA\*\*\*\*ENT-T-COLECO-13.95()
- \*\*\*\*FLASH FACTS:VOCABULATOR\*\*\*\*EDU-T-COLECO-13.95()
- \*\*\*\*FORTRAN-80\*\*\*\*CPM-D-Westico- (\$369.95)
- \*\*\*\*GAMES\*\*\*\*ENT-T-Steve Jacoby Co.-19.95(7 programs:checkers, hangman, portrait, liberty, Idaho Sq., Renegade, Dodgem)
- \*\*\*\*GAMES PACK 1\*\*\*\*ENT-DT-VICTORY SOFTWARE-20.95(3-programs: Gotchal, Street Sweepers, Cannoneers.)
- \*\*\*\*GEOMETRY 1\*\*\*\*EDU-DT-IMAGE MICROCORP-19.95(Tutors & drills in geometry.)
- \*\*\*\*GEOMETRY 2\*\*\*\*EDU-DT-IMAGE MICROCORP-19.95(More advanced tutoring & drills. (quadrilaterals))
- \*\*\*\*GRAPHICS EXPERIMENTER\*\*\*\*GRA-T-Nickelodeon Graphics-39.00()
- \*\*\*\*GREAT INVENTIONS GAME\*\*\*\*EDU-T-PARALLEL SYSTEMS-19.95(Learn about the world's greatest inventors.)
- \*\*\*\*GUST BUSTER\*\*\*\*ENT-T-SUNRISE SOFTWARE-14.95(Arcade action.)
- \*\*\*\*HACKER'S GUIDE TO ADAM\*\*\*\*UTI-T-Peter Hinkle-17.95(book & tape)
- \*\*\*\*HI-RES TEXT EDITOR\*\*\*\*GRA-T-Nickelodeon Graphics-29.00(Type text along side of hi-res graphics.)
- \*\*\*\*HOLIDAY SPELLING\*\*\*\*EDU-T-Micro 2-24.95()
- \*\*\*\*HOME APPLICATIONS & GAME\*\*\*\*FIN-DT-Steve Jacoby-19.95(ESP, music, medical records, saving on utility bills, etc..)
- \*\*\*\*HOME BONUS PACK\*\*\*\*FIN-T-MICRO 2-32.95(INCLUDES- YOU AND YOUR  
CHECKBOOK, INSURANCE FILE, CREDIT CARD, MICRO MONEY MINDER,  
& HOME AND BUSINESS INVENTORY)
- \*\*\*\*HOME BUDGET PLANNING\*\*\*\*FIN-T-PARALLEL SYSTEMS-9.95(Weekly, monthly or bi-monthly budgets.50 expense catagories.)
- \*\*\*\*HOME FILES MANAGER\*\*\*\*HOM-T-PARALLEL SYSTEMS-19.95(Mailing lists, inventory, mailing labels, etc...)
- \*\*\*\*HOME FINANCE\*\*\*\*FIN-T-Steve Jacoby Co.-19.95(5 programs)

# **\*\*SOFTWARE\*\***

**\*\*\*\*HOME MANAGEMENT SERIES I\*\*\*\*HOM-T-ADAM WORLD ENTERPRIS-29.95(INCLUDES:  
CHECK BOOK BALANCER ADDRESS LABEL MAKER COMPUTERIZED PHONE  
BOOK SCHOOL GRADE RECORDER CALENDER PROCESSOR HOME TUTORING SYSTEM  
METRIC CONVERSION SYSTEMCURRENCY)**

**\*\*\*\*HOME/OFFICE INVENTORY\*\*\*\*BUS-T-Micro 2-24.95()**

**\*\*\*\*HOUSEHOLD II LIBRARY\*\*\*\*HOM-T-DAVASAN SOFTWARE-39.95(15 programs  
SIGN PRINTER DIET MINDER CHECK PRINTER  
FEDERAL WITHOLDING ENVELOPE ADDRESSER ETC.)**

**\*\*\*\*HOUSHOLD LIBRARY\*\*\*\*HOM-T-DAVANSAN SOFTWARE-39.95(15 programs  
MONTHLY CALENDAR CALORIE COUNTER CHECKBOOK CONTROL HOME  
INVENTORY BIORHYTHMS ETC.)**

**\*\*\*\*INSURANCE FILE\*\*\*\*FIN-T-Micro 2-24.95()**

**\*\*\*\*INTERSTATE\*\*\*\*ENT-T-FUTURE VISION-9.95()**

**\*\*\*\*INTRO PHYSICS\*\*\*\*EDU-DT-CME Software-14.95(HS to Freshman)**

**\*\*\*\*INTRO TRIG\*\*\*\*EDU-DT-CME Software-14.95(Advanced student to high school,  
Sine, Cosine etc...)**

**\*\*\*\*INVESTMENT ANALYSIS\*\*\*\*BUS-T-MICRO 2-24.95()**

**\*\*\*\*IRA HISTORY\*\*\*\*FIN-DT-Kray Software-20.00(listing only:\$10.00 records of  
IRA savings account.)**

**\*\*\*\*IRA HISTORY\*\*\*\*HOM-TDL-KRAY-10.00(PRICE IS FOR A LISTING. ADD ONE TIME  
CHARGE OF \$10.00 PER PROGRAM(S) ORDER FOR EITHER TAPE ORDISK.  
Keeps track of IRA accts)**

**\*\*\*\*JANUS/ADA-80\*\*\*\*CPM-D-Westico-219.9(\$219.95 Language  
processor)**

**\*\*\*\*JEOPARDY\*\*\*\*ENT-T-COLECO-29.95()**

**\*\*\*\*KEYMAN\*\*\*\*ENT-T-Challenge Ware-19.95(Need LOGO,for kids ages 6-12.)**

**\*\*\*\*LA GREET\*\*\*\*EDU-DT-CME Software-9.95(Have ADAM print in foreign languages.)**

**\*\*\*\*LEARNING MORSE CODE\*\*\*\*EDU-DT-IMAGE MICROCORP-19.95(Learning tool for morse  
code.Vary speed & frequency.)**

**\*\*\*\*LIST\*\*\*\*BUS-DT-CME Software-?(Inventory,payroll,checkbook,cash accounting)**

**\*\*\*\*LYNX\*\*\*\*CPM-D-Westico-179.9(\$179.95 Development tool)**

**\*\*\*\*M-DESKMASTER\*\*\*\*BUS-T-Nickelodeon Graphics-19.95(keep track of small bus.  
expenses & income.)**

# \*\*SOFTWARE\*\*

\*\*\*\*M/SORT\*\*\*\*CPM-D-Westico- (\$139.95 Development tool)

\*\*\*\*M2CBASIC\*\*\*\*CPM-D-Westico- (\$129.95)

\*\*\*\*MACRO-80\*\*\*\*CPM-D-Westico- (\$149.95)

\*\*\*\*MAILCOM\*\*\*\*CPM-D-Westico- (Telecommunication software. \$139.95)

\*\*\*\*MAILFONE\*\*\*\*BUS-T-Steve Jacoby Co.-19.95(Mailing/telephone system)

\*\*\*\*MAILMERGE\*\*\*\*CPM-D-Westico- (\$179.95 Word Processing tool)

\*\*\*\*MAKE CHANGE\*\*\*\*EDU-T-Micro 2-24.95()

\*\*\*\*MARKET PRO\*\*\*\*CPM-D-Westico- (price is \$439.95)

\*\*\*\*MATH ONE\*\*\*\*EDU-DT-CME Software-14.95(Add,Sub,Mult & Div-ages 6-12)

\*\*\*\*MICRO MATH\*\*\*\*EDU-T-Micro 2-24.95(grades 2-5 addition & mult. skills /animated graphics.)

\*\*\*\*MICRO MONEY MINDER\*\*\*\*FIN-T-Micro 2-24.95(expense records.)

\*\*\*\*MICRO TOOLS\*\*\*\*CPM-D-Westico- (\$109.95)

\*\*\*\*MICROGANTT\*\*\*\*CPM-D-Westico- (\$289.95 Planning & Analysis)

\*\*\*\*MICROSOFT BASIC\*\*\*\*CPM-D-Westico- (\$259.95)

\*\*\*\*MICROSOFT BASIC COMPILER\*\*\*\*CPM-D-Westico- (\$289.95)

\*\*\*\*MICROSOFT COBOL\*\*\*\*CPM-D-Westico- (\$519.95)

\*\*\*\*MILESTONE\*\*\*\*CPM-D-Westico- (\$219.95 Planning & Analysis)

\*\*\*\*MIND TOOLS FOR MULIPLAN\*\*\*\*CPM-D-Westico-59.95(FINANCIAL PLANNING MINDTOOLS FOR MULIPLAN is the full title)

\*\*\*\*MIND TOOLS FOR SUPERCALC\*\*\*\*CPM-D-Westico-59.95(FINANCIAL PLANNING MIND TOOLS FOR SUPERCALC is the full title)

\*\*\*\*MONKEY ACADEMY\*\*\*\*EDU-C-COLECO-22.95(ages 8-adult,improving math skills.)

\*\*\*\*MOUNTAIN KING\*\*\*\*ENT-T-SUNRISE SOFTWARE-14.95()

\*\*\*\*muLISP/muSTAR\*\*\*\*CPM-D-Westico- (\$149.95)

\*\*\*\*MULTIPLAN\*\*\*\*CPM-D-Westico-139.9(\$139.95)

# \*\*SOFTWARE\*\*

- \*\*\*\*muMATH/muSIMP\*\*\*\*CPM-D-Westico- (\$179.95 Language Processor)
- \*\*\*\*PACKCOPY\*\*\*\*UTI-T-Sage Enterprises-39.50(Makes backup copies of most ADAM software.)
- \*\*\*\*PARTY TRIVIA\*\*\*\*ENT-T-PARALLEL SYSTEMS-15.95()
- \*\*\*\*PARTY TRIVIA GAME\*\*\*\*ENT-T-PARALLEL-19.95(CATEGORIES:TV, Hollywood, 50's, 60's, Baseball, Football.)
- \*\*\*\*PASCAL/MT+80\*\*\*\*CPM-D-Westico- (\$259.95 Language Processor)
- \*\*\*\*PAY\*\*\*\*BUS-DT-Steve Jacoby-19.95(accounts payable records,discout available.)
- \*\*\*\*PAYROLL\*\*\*\*BUS-T-STEVE JACOBY-19.95(keeps track of each employees account inc. deductions and special items. prints checks, pay envelopes and payroll summary.)
- \*\*\*\*PERSONAL ACCOUNTANT\*\*\*\*FIN-T-Softsync, INC.-24.00(Compiles financial reports,data base, amortization,payment schedules.)
- \*\*\*\*PERSONAL CHECKBOOK\*\*\*\*FIN-T-PARALLEL SYSTEMS-19.95(Complete checkbook record keeping system.Monthly summaries, etc...)
- \*\*\*\*PL/I-80\*\*\*\*CPM-D-Westico- (\$409.95)
- \*\*\*\*PLANFIN\*\*\*\*CPM-D-Westico- (\$139.95 Planning & Analysis)
- \*\*\*\*POSTMASTER\*\*\*\*CPM-D-Westico- (Data Management. \$109.95)
- \*\*\*\*POWERPRINT\*\*\*\*BUS-TD-Strategic Software-24.95(line centering, justification, etc for the printer)
- \*\*\*\*PRINTSHOP\*\*\*\*UTI-DT-CME Software-9.95(Signs,cards,etc.will be updated for Dot Matrix printer.)
- \*\*\*\*PRIORITIES\*\*\*\*CPM-D-Westico- (price is \$109.95)
- \*\*\*\*PROFIN\*\*\*\*CPM-D-Westico- (\$219.95 Planning & Analysis)
- \*\*\*\*PROPERTY MANAGEMENT\*\*\*\*FIN-T-Micro 2-24.95(tenant & rental records.)
- \*\*\*\*PS EXTRA\*\*\*\*UTI-DT-CME Software-9.95(Use with PRINTSHOP Prog.-)
- \*\*\*\*PSORT\*\*\*\*CPM-D-Westico-69.95()
- \*\*\*\*QUEST FOR QUINTANA ROO\*\*\*\*ENT-T-SUNRISE SOFTWARE-14.95()
- \*\*\*\*QUICKCODE\*\*\*\*CPM-D-Westico- (\$219.95 Development tool)

# \*\*SOFTWARE\*\*

- \*\*\*\*RATIOS\*\*\*\*BUS-DT-CME Software-19.95(Fin analysis pak.)
- \*\*\*\*READING FUN\*\*\*\*EDU-T-Micro 2-24.95(Grades 2-5,teaching vowels & rhyming words.)
- \*\*\*\*REAL ESTATE - SUPERCALC\*\*\*\*CPM-D-Westico-59.95(REAL ESTATE COMMERCIAL ANALYSIS FOR SUPERCALC is the full title.)
- \*\*\*\*REAL ESTATE APPRAISAL\*\*\*\*CPM-D-Westico- (\$289.95)
- \*\*\*\*REAL ESTATE FOR MULIPLAN\*\*\*\*CPM-D-Westico-89.95(REAL ESTATE OVERLAYS FORMULTIPLAN is the full title)
- \*\*\*\*RECEIVE\*\*\*\*BUS-T-Steve Jacoby Co.-19.95(An accounts receivable program)
- \*\*\*\*RECIPE\*\*\*\*HOM-T-Steve Jacoby Co.-19.95(Recipe filer.)
- \*\*\*\*RECIPE FILER\*\*\*\*HOM-TD-COLECO-19.95()
- \*\*\*\*RENUMBER\*\*\*\*UTI-DT-Kray Software-17.00(listing only:\$7.00 Renumbers lines in Basic.)
- \*\*\*\*RENUMBER\*\*\*\*UTI-TDL-KRAY-7.00(PRICE IS FOR A LISTING. ADD ONE TIME CHARGE OF \$10.00 PER PROGRAM(S) ORDER FOR EITHER TAPE ORDISK.)
- \*\*\*\*RESUME\*\*\*\*BUS-T-Challenge Ware-19.95(Instant personalized resume.)
- \*\*\*\*ROLLOVERTURE\*\*\*\*MUS-T-SUNRISE SOFTWARE-14.95()
- \*\*\*\*SAVINGS & LOAN\*\*\*\*FIN-DT-Steve Jacoby-19.95(home finances)
- \*\*\*\*SAVINGS & LOANS\*\*\*\*FIN-DT-VICTORY SOFTWARE-20.95(Calculates interest, principal, monthly payments,annuity funds, savings accounts, IRA, etc...)
- \*\*\*\*SEARCH FOR RUBY CHALICE\*\*\*\*ENT-T-INCO-19.95()
- \*\*\*\*SECRET M.\*\*\*\*EDU-DT-CME Software-14.95(Code & decode your secret messages.
- \*\*\*\*SHAPEMASTER I\*\*\*\*GRA-T-Nickelodeon Graphics-29.00(Create your own shapes for use in games & commercial programs.)
- \*\*\*\*SMAL/80\*\*\*\*CPM-D-Westico-109.9(\$109.95 Language Processor)
- \*\*\*\*SMART LETTERS & FORMS\*\*\*\*HOM-T-COLECO-24.95()
- \*\*\*\*SMART LOGO\*\*\*\*GRA-T-COLECO-59.95()
- \*\*\*\*SmartBASIC BONANZA\*\*\*\*VAR-T-Martin Consulting-34.95(15-programs,large variety,games, filer, assembler,breakout, othello, design, sounder, etc...)
- \*\*\*\*SMARTFILER\*\*\*\*HOM-T-COLECO-19.95() -13-

# **\*\*SOFTWARE\*\***

- \*\*\*\*SMARTPELLER\*\*\*\*BUS-DT-Strategic Software-39.95(Finds misspelled words in wordprocessing documents)
- \*\*\*\*SMARTPELLER\*\*\*\*HOM-T-ADAM WORLD ENTERPRIS-39.95(DICTIONARY FOR WORD PROCESSING)
- \*\*\*\*SMURF PAINT N'PLAY\*\*\*\*EDU-C-COLECO-22.95(Ages 4-10,role play,color& shape recognition,graphic composition.)
- \*\*\*\*SPEED PROGRAMMING PKG-80\*\*\*\*CPM-D-Westico- (\$149.95 Development tool)
- \*\*\*\*SPRING/80 SOURCE CODE\*\*\*\*CPM-D-Westico- (\$219.95)
- \*\*\*\*STARINDEX\*\*\*\*CPM-D-Westico- (\$139.95 Word Processing)
- \*\*\*\*STATECAPITALS\*\*\*\*EDU-DT-CME Software-14.95(US State Caps.)
- \*\*\*\*STATEGY PACK 1\*\*\*\*ENT-DT-VICTORY SOFTWARE-20.95(4-programs:Payoff, HI-Q, Jump, Othello.)
- \*\*\*\*STATES & CAPITALS GAME\*\*\*\*EDU-T-PARALLEL-19.95()
- \*\*\*\*STATES AND CAPITALS\*\*\*\*EDU-T-PARALLEL SYSTEMS-15.95()
- \*\*\*\*STATPACK\*\*\*\*CPM-D-Westico- (\$369.95 Planning & Analysis)
- \*\*\*\*STOCK PROFILE\*\*\*\*FIN-T-Micro 2-24.95(chart profit/loss)
- \*\*\*\*STRATEGIC ALT\*\*\*\*BUS-DT-CME Software-19.95(Marketing pak.)
- \*\*\*\*STRING/80\*\*\*\*CPM-D-Westico-69.95()
- \*\*\*\*SUPER ZAXXON\*\*\*\*ENT-T-COLECO-29.95()
- \*\*\*\*SUPERCALC\*\*\*\*CPM-D-Westico- (\$139.95)
- \*\*\*\*SUPERCALC 2\*\*\*\*CPM-D-Westico- (\$219.95)
- \*\*\*\*SUPERONE\*\*\*\*BUS-DT-Steve Jacoby-19.95(two checking accounts)
- \*\*\*\*SUPERSORT\*\*\*\*CPM-D-Westico- (\$179.95)
- \*\*\*\*T/MAKER III\*\*\*\*CPM-D-Westico- (\$199.95 Planning & Analysis)
- \*\*\*\*TAX PLANNER\*\*\*\*CPM-D-Westico- (\$219.95)
- \*\*\*\*TEACHER'S FILE\*\*\*\*EDU-DT-CME Software-19.95(Gathers stats & keeps files on students.)



# \*\*SOFTWARE\*\*

- \*\*\*\*TEACHER'S HELP\*\*\*\*EDU-DT-CME Software-19.95(Assists teachers in calculating statistics for exams & quizzes.)
- \*\*\*\*TELLY TURTLE\*\*\*\*EDU-C-COLECO-22.95(Ages 5-15,intro to programming,logical thinking,creativity.)
- \*\*\*\*THE COSSART WARS\*\*\*\*ENT-T-Nickelodeon Graphics-?()
- \*\*\*\*THE KNOWLEDGE FACTORY\*\*\*\*EDU-T-Nickelodeon Graphics-?()
- \*\*\*\*THE PIANOMAN\*\*\*\*MUS-T-DAVASAN SOFTWARE-29.95(ELECTRONIC VERSION OF THE OLD PLAYER PIANO WITH NEW TWISTS. TEACHESMUSIC AND FUNDAMENTALS.)
- \*\*\*\*THE REEDY LIBRARY\*\*\*\*UTI-TD-REEDY SOFTWARE-24.95(DISK-22.95 Tape-24.95 INCLUDES: MICHIGANA JONES HI-RES TEXTEDITOR VIDEOPAINT PICTURE SUBROUTINE MKR AND OTHERS)
- \*\*\*\*THE RIB\*\*\*\*UTI-T-Tapeware Technology-32.95(2 Data Packs. 14 utilities and 5 tutorials.)
- \*\*\*\*THE SECRETARY\*\*\*\*CPM-D-Elliam Associates-12.00(PD CP/M word processing program.)
- \*\*\*\*THE STOCK MARKET GAME\*\*\*\*ENT-DT-IMAGE MICROCORP-24.95(Board style game. Works just like the real stock market.)
- \*\*\*\*THE ULTIMATE ADVENTURE\*\*\*\*ENT-T-INCO-19.95()
- \*\*\*\*THE WORD BUG\*\*\*\*EDU-T-Micro 2-24.95(New producr-info unavailable at press time.)
- \*\*\*\*TOMB\*\*\*\*ENT-T-INCO-19.95()
- \*\*\*\*TREK\*\*\*\*ENT-DT-VICTORY SOFTWARE-20.95(Destroy the Klingon invasion before time runs out. A classic.)
- \*\*\*\*TUNEMAKER\*\*\*\*MUS-T-Nickelodeon Graphics-8.00(Sold only w/Hi-res Text Editor or Shapemaster I)
- \*\*\*\*TYPEQUICK\*\*\*\*CPM-D-Westico-59.95()
- \*\*\*\*TYPETEST II\*\*\*\*EDU-T-Nickelodeon Graphics-25.00(Multi-level skill developer for typing skills.)
- \*\*\*\*ULTRASORT II\*\*\*\*CPM-D-Westico- (\$119.95)
- \*\*\*\*UNCLE ERNIES TOOL KIT\*\*\*\*UTI-TD-UNCLE ERNIE'S SOFTWR-23.00(\$25.00 for DP \$23.00 for Disk)
- \*\*\*\*UTILITIES\*\*\*\*UTI-T-Steve Jacoby Co.-19.95(4 programs)

# \*\*SOFTWARE\*\*

- \*\*\*VEDIT-80\*\*\*CPM-D-Westico- (\$109.95 Development tool)
- \*\*\*VIDEO TUNES\*\*\*MUS-T-FUTURE VISION-29.95()
- \*\*\*WACKY WORD GAMES\*\*\*ENT-T-COLECO-19.95()
- \*\*\*WORDSTAR\*\*\*CPM-D-Westico- (\$369.95 Word Processing)
- \*\*\*WORLD CAPITALS\*\*\*EDU-T-PARALLEL SYSTEMS-15.95()
- \*\*\*WORLD CAPITALS GAME\*\*\*EDU-T-PARALLEL-19.95(Learn world capitals with colorful graphics computer style.)
- \*\*\*WRITER'S ASSISTANT\*\*\*BUS-T-DAVASAN SOFTWARE-39.95(ASSISTS IN TERM PAPERS, FORM LETTERS, INVITATIONCHARTS, GRAPHS, NEWS- LETTERS. WORKS WITH SMARTWRITER. LINE CENTERING AND RIGHTJUSTIFICATION.)
- \*\*\*XASM CROSS ASSEMBLER\*\*\*CPM-D-Westico- (\$149.95)
- \*\*\*YOU & YOUR CHECKBOOK\*\*\*FIN-T-Micro 2-24.95()



## 2.SOFTWARE BY CATEGORY

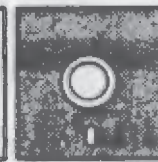

### BUSINESS

ADAM CALC  
ADAM FILER  
ANALYSIS  
B-DESK MASTER  
BOND AMORT  
BUSINESS BONUS PAK  
BUSINESS GRAPHS PAK  
DATA CALC  
DATA FILER  
DATA KEEPER  
DATACALC  
DAWN  
EASYPERT  
F-DESK MASTER  
FAST FILER  
HOME/OFFICE INVENTORY

INVESTMENT ANALYSIS  
LIST  
M-DESKMASTER  
MAILFONE  
PAY  
PAROLL  
POWERPRINT  
RATIOS  
RECEIVE  
RESUME  
SMARTSPELLER  
STRATEGIC ALT  
SUPERONE  
WRITER'S ASSISTANT

### EDUCATIONAL

ABC'S  
BRAIN STRAINERS  
COUNTING  
EDUCATION  
EDUCATION BONUS PACK  
EDUCATION LIBRARY  
EDUCATION II LIBRARY  
EDUCATIONAL PRIGRAMS  
ELECTRONIC FLASHCARD MAKER  
EUROCAPITALS  
EXPERTYPE  
FLASH FACTS:FLASH BACKS  
FLASH FACTS:VOCABULATOR  
GEOMETRY I  
GEOMETRY II

GREAT INVENTIONS GAME  
HOLIDAY SPELLING  
INTRO PHYSICS  
INTRO TRIG  
LA GREET  
LEARNING HORSE CODE  
MAKE CHANGE  
MATH ONE  
MICRO MATH  
MONKEY ACADEMY  
READING FUN  
SECRET M.  
SMURF PAINT N' PLAY WORKSHOP

## UTILITIES

CONVERT  
CP/M 2.2 + ASSEMBLER  
CUE CARDS  
DISASSEMBLER  
EXTENDED BASIC UTILITIES  
HACKER'S GUIDE TO ADAM  
PACKCOPY  
PRINTSHOP  
PS EXTRA  
RENUMBER  
THE REEDY LIBRARY  
THE RIB  
UNCLE ERNIE'S TOOL KIT  
UTILITIES

## FINANCES

CASH FLOW ANALYSIS  
CREDIT CARD FILE  
EARN-SAVE HISTORY  
HOME APPLICATIONS & GAME  
HOME BONUS PACK  
HOME BUDGET PLANNING  
HOME FINANCE  
INSURANCE FILE  
IRA HISTORY  
MICR MONEY MINDER  
PERSONAL ACCOUNTANT  
PERSONAL CHECKBOOK  
PROPERTY MANAGEMENT  
SAVINGS & LOAN  
SAVINGS & LOANS  
STOCK PROFILE  
YOU & YOUR CHECKBOOK

## HOME

ADDRESS BOOK & AUTODIALER  
ADDRESS LABELS  
EARN SAVE HISTORY  
FAMILY ACCOUNTING  
HOME FILES MANAGER  
HOME MANAGEMENT  
HOUSEHOLD LIBRARY SERIES 1  
HOUSEHOLD II LIBRARY  
IRA HISTORY  
RECIPE  
RECIPE FILER  
SMART LETTERS & FORMS  
SMART FILER  
SMART SPELLER

## GRAPHICS

ARTISTS PAD  
GRAPHICS EXPERIMENTER  
HI-RES-TEXT EDITOR  
SHAPEMASTER 1  
SMART LOGO

## \*\*SOFTWARE\*\*

## ENTERTAINMENT

32-BASIC PROGRAMS  
ADVENTURE PACK I  
ADVENTURE PACK  
ADVENTURE PACK II  
APPIAN WAY  
BASIC GAME LIBRARY  
BEST ELECTRONIC WORDGAME EVER  
BEST OF BRODERBUND  
BEST OF ELECTRONIC ARTS  
BEST OF SIERRA  
BLACK GOLD  
BOUNTY HUNTER  
CAMPAIN '84  
CASTLE OF DOOM  
DIABLO  
DONKEY KONG  
DONKEY KONG JR.  
DRAGON'S CAVERN  
DRAGON'S LAIR  
FAMILY FEUD  
FANTASY GAMER  
FLASH FACTS  
GAMES  
GAMES PACK I  
GUST BUSTER  
INTERSTATE  
JEOPARDY  
KEYMAN  
MOUNTAIN KING  
PARTY TRIVIA  
PARTY TRIVIA GAME  
QUEST FOR QUINTANA ROO  
SEARCH FOR RUBY CHALICE  
STRATEGY PACK 1  
SUPER ZAXXON  
THE COSSART WARS  
THE STOCK MARKET GAME  
THE ULTIMATE ADVENTURE  
TOMB  
TREK  
WACKY WORD GAMES

## MUSIC

ROLLOVERTURE  
THE PIANO MAN  
TUNEMAKER  
VIDEO TUNES

## CP/M

ACCESS MANAGER-80  
ASCOM  
BDS C  
BPSxref  
BUYSEL  
C PROGRAMMING LANGUAGE  
CB-80

## CP/M

CBASIC-80  
CONDOR 20-1  
CP/M WORKSHOP  
DATEBOOK II  
DBASE II  
DBGRAPH  
DISPLAY MANAGER-80  
DR ASSEMBLER & TOOLS  
duTIL  
ELECTRONIC CIRCUIT ANAL  
FORTRAN-80  
JANUS/ADA-80  
LYNX  
H/SORT  
M2BASIC  
MACRO-80  
MAILCOM  
MAILMERGE  
MARKET PRO  
MICRO TOOLS  
MICROGANTT  
MICROSOFT BASIC  
MICROSOFT BASIC COMPILER  
MICROSOFT COBOL  
MILESTONE  
MIND TOOLS FOR MULTIPLAN  
MID TOOLS FOR SUPERCALC  
muLISP/muSTAR  
MULTIPLAN  
muMATH/muSIMP  
PASCAL/MT+80  
PL/I-80  
PLANFIN  
POSTMASTER  
PRIORITIES  
PROFIN  
PSORT  
QUICKCODE  
REAL-ESTATE-SUPERCALC  
REAL ESTATE APPRAISAL  
REAL ESTATE FOR MULTIPLAN  
SMAL/80  
SPEED PROGRAMMING PKB-80  
SPRING/80 SOURCE CODE  
STARINDEX  
STATPACK  
STRING/80  
SUPERCALC  
SUPERCALC 2  
SUPERSORT  
T/MAKER III  
TAX PLANNER  
THE SECRETARY  
TYPEQUICK  
ULTRASORT  
VEDIT-80  
WORDSTAR  
XASH CROSS ASSEMBLER

# 3. CARTRIDGE SOFTWARE

**\*SOFTWARE\***

- \*\*\*2010 Graphic Action  
Coleco-\$22.95
- \*\*\*Alphabet Zoo  
Spinnaker-\$23.95
- \*\*\*Antartic Adventure  
Coleco-\$22.95
- \*\*\*Artillery Dual  
Xonox-\$14.95
- \*\*\*BC Grog's Revenge  
Coleco-\$22.95
- \*\*\*BC Quest for Tires  
Sierra-\$27.95
- \*\*\*Beam Rider  
Activision-\$19.95
- \*\*\*Blackjack/Poker  
Coleco-\$19.95
- \*\*\*Blockaid Runner  
Interphase-\$9.97
- \*\*\*Brainstrainers  
Coleco-\$22.95
- \*\*\*Buck Rogers  
Coleco-\$22.95
- \*\*\*Bump and Jump  
Coleco-\$14.95
- \*\*\*Burger Time  
Coleco-\$22.95
- \*\*\*Cabbage Patch Park  
Coleco-\$22.95
- \*\*\*Cabbage Ptch Picture  
Coleco-\$22.95
- \*\*\*Campaign '84  
Sunrise-\$16.95
- \*\*\*Carnival  
Coleco-\$9.95
- \*\*\*Ch.Norris Superkicks  
Xonox-\$14.95
- \*\*\*Championship Tennis  
Imagic-\$13.95
- \*\*\*Choplifter  
Coleco-\$22.95
- \*\*\*Congo Bongo  
Coleco-\$22.95
- \*\*\*Cosmic Avenger  
Coleco-\$14.95
- \*\*\*Dam Busters  
Coleco-\$22.95
- \*\*\*Decathalon  
Activision-\$27.95
- \*\*\*Decathlon  
Activision-\$14.95
- \*\*\*Destructor (exp. #2)  
Coleco-\$22.95
- \*\*\*Donkey Kong Jr.  
Coleco-\$9.95
- \*\*\*Dragon Fire  
Imagic-\$13.95
- \*\*\*Dukes of Hazzard (#2)  
Coleco-\$22.95
- \*\*\*Face Maker  
Spinnaker-\$23.95
- \*\*\*Fathom  
Imagic-\$13.95
- \*\*\*Football (use S.A.C)  
Coleco-\$22.95
- \*\*\*Fortune Builder  
Coleco-\$22.95
- \*\*\*Fraction Fever  
Spinnaker-\$23.95

# \*\*SOFTWARE\*\*

## CARTRIDGE SOFTWARE

- \*\*\*Frantic Freddy  
Spectravision-\$24.95
- \*\*\*Frenzy  
Coleco-\$22.95
- \*\*\*Frogger  
Parker Bro.-\$19.95
- \*\*\*Frogger II  
Parker Bro.-\$34.95
- \*\*\*Front Line (use SAC)  
Coleco-\$22.95
- \*\*\*Gateway to Apshai  
Epyx-\$15.95
- \*\*\*Gorf  
Coleco-\$19.95
- \*\*\*Gust Buster  
Sunrise-\$16.95
- \*\*\*Gyruss  
Parker Bro.-\$32.95
- \*\*\*Heist  
Microfun-\$14.95
- \*\*\*Hero  
Activision-\$27.95
- \*\*\*Illusions  
Coleco-\$22.95
- \*\*\*It's Only Rock N'Rol  
Xonox-\$14.95
- \*\*\*James Bond  
Parker Bro.-\$34.95
- \*\*\*Juke Box  
Spinnaker-\$23.95
- \*\*\*Jumpman Junior  
Epyx-\$15.95
- \*\*\*Keystone Kapers  
Activision-\$27.95
- \*\*\*Lady Bug  
Coleco-\$19.95
- \*\*\*Learning with Leeper  
Sierra-\$24.95
- \*\*\*Logic Levels  
Fisher Price-\$9.97
- \*\*\*Looping  
Coleco-\$19.95
- \*\*\*Miner 2049er  
Microfun-\$14.95
- \*\*\*Mixed-Up Puzzler  
Coleco-\$22.95
- \*\*\*Moemory Manor  
Fisher Price-\$9.97
- \*\*\*Monkey Academy  
Coleco-\$22.95
- \*\*\*Montezuma's Revenge  
Parker Bro.-\$32.95
- \*\*\*Moonsweeper  
Imagic-\$13.95
- \*\*\*Mountain King  
Sunrise-\$16.95
- \*\*\*Mouse Trap  
Coleco-\$19.95
- \*\*\*MR. DO!  
Coleco-\$22.95
- \*\*\*Mr. Do's Castle  
Parker Bro.-\$32.95
- \*\*\*Nova Blast  
Imagic-\$13.95
- \*\*\*Oil's Well  
Sierra-\$24.95
- \*\*\*Omega Race (roller)  
Coleco-\$22.95
- \*\*\*One on One  
Microfun-\$21.95
- \*\*\*Pepper II  
Coleco-\$22.95

# \*\*SOFTWARE\*\*

## CARTRIDGE SOFTWARE

\*\*\*Pitfall  
Activision-\$27.95

\*\*\*Pitfall II  
Activision-\$27.95

\*\*\*Pitstop  
Epyx-\$15.95

\*\*\*Popeye  
Parker Bro.-\$19.95

\*\*\*Q-Bert  
Parker Bro.-\$19.95

\*\*\*Q-Bert II  
Parker Bro.-\$34.95

\*\*\*Quest Quintana Roo  
Sunrise-\$16.95

\*\*\*River Raid  
Activision-\$27.95

\*\*\*Roc n Rope  
Coleco-\$14.95

\*\*\*Rocky (use SAC)  
Coleco-\$22.95

\*\*\*Rolloverture  
Sunrise-\$16.95

\*\*\*Root Beer Tapper  
Coleco-\$22.95

\*\*\*Sammy Lightfoot  
Sierra-\$24.95

\*\*\*Slurpy  
Xonox-\$14.95

\*\*\*Smurf Paint n Play  
Coleco-\$22.95

\*\*\*Star Trek  
Coleco-\$22.95

\*\*\*Star Wars  
Parker Bro.-\$34.95

\*\*\*Sub Roc  
Coleco-\$22.95

\*\*\*Smurf Rescue  
Coleco-\$19.95

\*\*\*Space Fury  
Coleco-\$19.95

\*\*\*Space Panic  
Coleco-\$19.95

\*\*\*Spectron  
Spectravision-\$24.95

\*\*\*Super Cobra  
Parker Bro.-\$32.95

\*\*\*Super Cross Force  
Spectravision-\$24.95

\*\*\*Tarzan  
Coleco-\$22.95

\*\*\*Telly Turtle  
Coleco-\$22.95

\*\*\*Thinking Logic  
Fisher Price-\$9.97

\*\*\*Threedeeep  
Parker Bro.-\$9.95

\*\*\*Threshold  
Sierra-\$24.95

\*\*\*Time Pilot  
Coleco-\$19.95

\*\*\*Tutankum  
Parker Bro.-\$32.95

\*\*\*Up N' Down  
Sega-\$14.95

\*\*\*Venture  
Coleco-\$19.95

\*\*\*Victory (roller)  
Coleco-\$9.95

\*\*\*War Games  
Coleco-\$22.95

\*\*\*War Games  
Coleco-\$22.95

\*\*\*Wing War  
Imagic-\$13.95

\*\*\*Wizard Id Wiz Math  
Sierra-\$24.95

\*\*\*Zaxxon  
Coleco-\$19.95

\*\*\*Zenji  
Activision-\$27.95



DON'T EVER USE ADAM  
IN YOUR POOL...  
BELIEVE ME,  
I KNOW!!!!!!!!!!!!

# the ADAM™ SECTION Resource TWO (#2)

P.O. BOX 90  
SEELYVILLE, INDIANA 47878



## HARDWARE & ACCESSORIES



WE HAVE LIMITED THIS SECTION TO ADAM HARDWARE AND ACCESSORIES WHICH ARE UNIQUE TO ADAM. THERE ARE MANY COMPUTER SUPPLIES THAT CAN BE USED WITH ADAM AND THEY ARE READILY AVAILABLE AT YOUR LOCAL STORE. DISKS, PAPER, ETC.. ARE NOT INCLUDED IN THIS LISTING.

# \*\*HARDWARE\*\*

- \*\*\*\*80-COLUMN CARD \*\*\*\* QUEST CUSTOM VIDEO- (WITH LIGHT PEN CAPABILITY.)
- \*\*\*\*ADAM 5 1/4" DISK DRIVE \*\*\*\* COLECO-\$199 ( )
- \*\*\*\*ADAM 64K MEMORY EXPANDER \*\*\*\* COLECO-\$99 ( )
- \*\*\*\*ADAM BLANK DIGITAL DATA PACK\*\*\*\* COLECO-\$6.95 ( )
- \*\*\*\*ADAM COMPUTER MODULE \*\*\*\* COLECO-\$199 (AD-ON SYSTEM, REQUIRES COLECOVISION.)
- \*\*\*\*ADAM COMPUTER SYSTEM \*\*\*\* COLECO-\$299 ((STAND-ALONE VERSION))
- \*\*\*\*ADAM COOLER COOLING FAN \*\*\*\* -29.95 (115 VOLT 60 CYCLE COOLING FAN. FOR PROLONGED USE OF ADAM.)
- \*\*\*\*ADAM DIGITAL DATA DRIVE \*\*\*\* COLECO-\$99 (2nd DRIVE)
- \*\*\*\*ADAM HANDLER PRINTER STAND\*\*\*\* -49.95 (AS CLOSE TO POSSIBLE TO TRACTOR FEED WITHOUT THETRACTOR FEED.)
- \*\*\*\*ADAM REPLACEMENT DAISYWHEELS\*\*\*\* COLECO-\$5.95 (AVAILABLE IN VARIOUS STYLES. EXAMPLES COUTESY OF M.W. RUTH COMPANY.)

PICA 10 (This comes with ADAM  
\<1234567890-+^ qwertyuiop[] asdfghjkl;' zxcvbnm,./  
!@#\$\$%\_&\*()'^~ QWERTYUIOP{} ASDFGHJKL:" ZXCVBNM<>?

PRESTIGUE PICA 10  
|1234567890-+& qwertyuiop[] asdfghjkl;' zxcvbnm,./  
°!@#\$\$%\_&\*()†=° QWERTYUIOP¶° ASDFGHJKL:" ZXCVBNM<>?

ELITE  
\<1234567890-+^ qwertyuiop[] asdfghjkl;' zxcvbnm,./  
!@#\$\$%\_&\*()'^~ QWERTYUIOP{} ASDFGHJKL:" ZXCVBNM<>?

PRESTIGE ELITE  
\<1234567890-+^ qwertyuiop[] asdfghjkl;' zxcvbnm,./  
!@#\$\$%\_&\*()'^~ QWERTYUIOP{} ASDFGHJKL:" ZXCVBNM<>?

COURIER 10  
\<1234567890-+^ qwertyuiop[] asdfghjkl;' zxcvbnm,./  
|!@#\$\$%\_&\*()'^~ QWERTYUIOP{} ASDFGHJKL:" ZXCVBNM<>?

COURIER 72  
\<1234567890-+^ qwertyuiop[] asdfghjkl;' zxcvbnm,./  
!@#\$\$%\_&\*()'^~ QWERTYUIOP{} ASDFGHJKL:" ZXCVBNM<>?

LETTER GOTHIC  
\<1234567890-+^ qwertyuiop[] asdfghjkl;' zxcvbnm,./  
!@#\$\$%\_&\*()'^~ QWERTYUIOP{} ASDFGHJKL:" ZXCVBNM<>?



# \*\*HARDWARE\*\*

## FORMS GOTHIC

\1234567890-+^ qwertyuiop[] asdfghjkl;' zxcvbnm,./  
|!@#\$\$%\_&\*()'^~ QWERTYUIOP{} ASDFGHJKL:" ZXCVCBNM<>?

## DUAL GOTHIC

Ⓢ1234567890-+Ⓢ qwertyuiop[] asdfghjkl;' zxcvbnm,./  
¶!@#\$\$%\_&\*()°=™ QWERTYUIOP\$† ASDFGHJKL:" ZXCVCBNM<>?

## EMPHASIS

\1234567890-+▪ QWERTYUIOP[] ASDFGHJKL;' ZXCVCBNM,./  
|!¶#\$\$%\_&\*()°=† QWERTYUIOP‡ ASDFGHJKL:" ZXCVCBNM<>?

## BOOKFACE ACADEMIC 10

Ⓢ1234567890-+Ⓢ qwertyuiop[] asdfghjkl;' zxcvbnm,./  
¶!@#\$\$%\_&\*()°=™ QWERTYUIOP\$† ASDFGHJKL:" ZXCVCBNM<>?

## SCRIPT

Ⓢ1234567890-+Ⓢ qwertyuiop[] asdfghjkl;' zxcvbnm,./  
¶!@#\$\$%\_&\*()°=™ QWERTYUIOP\$† ASDFGHJKL:" ZXCVCBNM<>?

## ITALIC

Ⓢ1234567890-+Ⓢ qwertyuiop[] asdfghjkl;' zxcvbnm,./  
¶!@#\$\$%\_&\*()°=™ QWERTYUIOP\$† ASDFGHJKL:" ZXCVCBNM<>?

- \*\*\*\*ADAM REPLACEMENT RIBBON \*\*\*\* COLECO-\$6.95 ( )
- \*\*\*\*ADAMLink DIRECT CONNECT MODEM\*\*\*\* COLECO-\$99 ( )
- \*\*\*\*COLECOVISION \*\*\*\* COLECO-\$99 (GAME SYSTEM)
- \*\*\*\*COLECOVISION/ADAM ROLLER CONTROLLER\*\*\*\* COLECO-\$75 ( )
- \*\*\*\*COLECOVISION/ADAM SUPER ACTION CONTROLLER\*\*\*\* COLECO-\$75 ( )
- \*\*\*\*DATA DRIVE HEAD CLEANER PADS\*\*\*\* DATA BACKUP-2.50 (FOIL PACKETS WITH  
PADS SATURATED WITH 91% ISOPROPYL ALCOHOL. 5 PACKETS.)
- \*\*\*\*DUST COVER SET FOR MEMORY CONSOLE\*\*\*\* DATA BACKUP-9.95 (LIGHTWEIGHT  
NYLON FABRICCOVERS. \$1.00 SHIPPING)
- \*\*\*\*DUST COVER SET-FOR PRINTER & KEYBOARD\*\*\*\* DATA BACKUP-12.95  
(LIGHTWEIGHT NYLON FABRICCOVERS. \$1.00 SHIPPING)
- \*\*\*\*EXPANSION MODULE #1 \*\*\*\* COLECO-\$39 (ALLOWS YOU TO PLAY ATARI 2600 GAME  
CARTS.)
- \*\*\*\*EXPANSION MODULE #2 \*\*\*\* COLECO-\$50 (DRIVING MODULE)
- \*\*\*\*FRONT MOUNT SWITCH AND PRINTER LEG SET\*\*\*\* DATA BACKUP-22.95 (MOVES  
ON/OFF SWITCH TO FRONT OF PRINTER. LEGS ALLOW FAN FOLD PAPER TO BE PLACED  
UNDER PRINTER.NO ELECTRICAL MODIFICATION. \$2.00 SHIPPING.)

# \*\*HARDWARE\*\*

- \*\*\*\*JOYSTICK/KEYPAD \*\*\*\* WICO-20.00 (REPLACEMENT JOYSTICK)
- \*\*\*\*JOYSTICK/KEYPAD \*\*\*\* AMIGA-17.00 (REPLACEMENT JOYSTICK)
- \*\*\*\*JOYSTICK/KEYPAD \*\*\*\* COLECO-24.00 (REPLACEMENT JOYSTICK)
- \*\*\*\*RS-232/CENTRONICS INTERFACE\*\*\*\* EVE ELECTRONICS SYS.-\$139 (REQUIRES DISK DRIVE.SERIAL & PARALLEL.INCLUDES SOFTWARE.\$6 SHIPPING.)
- \*\*\*\*RS-232/CENTRONICS INTERFACE\*\*\*\* QUEST CUSTOM VIDEO-\$129 (INCLUDES SOFTWARE AND SERIAL CORD.USES RADIO SHACK PARALLEL CORD FOR THE MODEL 100 COMPUTER.)
- \*\*\*\*SUPER SKETCH \*\*\*\* PERSONAL PERIPHERALS- (AS STYLUS IS MOVED ACROSS THE CONTROLLER PAD, AN IMAGE IS CREATED ON THE TV SCREEN. SKETCHMASTER SOFTWARE CARTRIDGE INCLUDED.)
- \*\*\*\*TRACTOR FEED \*\*\*\* -79.95 (NO TOOLS NEEDED TO INSTALL. STAINLESS STEEL AND ALUMIUM.)

I LOVE ADAM !



# the ADAM<sup>TM</sup> Resource

P.O. BOX 90  
SEELYVILLE, INDIANA 47878



## SECTION THREE (#3)

# RETAILERS

THIS SECTION LISTS NAMES, ADDRESSES, PHONE NUMBERS, AND OTHER IMPORTANT INFO AS TO WHERE YOU CAN PURCHASE ADAM PRODUCTS. FOR A MORE DETAILED LISTING OF SPECIFIC ADAM ITEMS, AND WHERE TO GET THEM, WE SUGGEST YOU REFER TO THE "AD-SECTION" OF THIS DIRECTORY AS MANY OF THE LEADING ADAM SUPPLIERS ARE INCLUDED IN THAT SECTION.

**NOTE:** IF THERE IS NO NOTATION FOLLOWING A PARTICULAR LISTING, IT IS TO BE ASSUMED THE COMPANY CARRIES SOFTWARE ONLY.

### **ATTENTION RETAILERS:**

IF YOU ARE NOT LISTED HERE, OR NEED TO MAKE A CHANGE IN YOUR LISTING - DROP US A CARD WITH INFO TO:

**THE ADAM RESOURCE  
DEPT. 30 BOX 90  
SEELYVILLE, IN 47878**

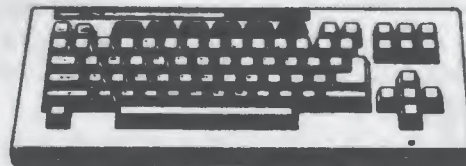

### **EDITOR'S NOTE:**

WE HAVE ATTEMPTED TO INCLUDE AS MUCH INFO AS POSSIBLE ABOUT EACH RETAILER, HOWEVER, SOME RETAILERS NEVER RESPONDED TO OUR LETTERS AND THEREFORE WE COULD NOT GET THE INFO, OR WE HAD TO GET IT FROM ANOTHER SOURCE.

# \*RETAILERS\*

\*\*\*\*\*

ADAM INFO-P.HINKLE  
117 Northview Rd  
Ithaca, NY 14850

Publishes Hacker's  
Guide to ADAM

\*\*\*\*\*

C&C DISTRIBUTERS  
P.O.BOX 76  
Stratford, NJ 08084

Software, program  
listings

\*\*\*\*\*

ADAM WORLD ENTERPRISES  
424 E. John St.  
Linden Hurst, NY 11757

Software

\*\*\*\*\*

CALDERON ENTERPRISES  
155 Dehart Ave.  
Staten Island, NY 10303

Software, program lists

\*\*\*\*\*

ADAM'S APPLE  
4835 Edsal  
Cleveland, OH 44124

Software, newsletter,  
public dom.soft

\*\*\*\*\*

COLECO INDUSTRIES  
23 Chelton Ave.  
West Hartford, CT 06110

\*\*\*\*\*

COMMAND COMPUTERS  
9229 Todd Drive #104  
Birmingham, AL 35206  
205-833-9376

\*\*\*\*\*

ADAM-HACK PRODUCTIONS  
P.O. BOX 184  
Seelyville, IN 47878

Software-Family-Pak  
See Ad-Section

Software & Accessories

\*\*\*\*\*

DATA BACK-UP  
BOX 335  
Iona, ID 83427

\*\*\*\*\*

ADAM-X-CHANGE  
12863 Washburn  
Wolcott, NY 14590

Data Paks, Misc  
Accessories.

\*\*\*\*\*

ADAMWARE  
711 Pecan Dept. F-7  
Texarkana, AR 75502

\*\*\*\*\*

DAVASAN SOFTWARE  
S. 1829 Glenrose Rd.  
Spokane, WA 99203

Software & supplies

\*\*\*\*\*

ALPHA-1  
1671 E.16th St.Suite 146  
Brooklyn, NY 11229  
718-336-7612

Software, Hardware,  
& Misc. supplies

\*\*\*\*\*

DELTA MICRONICS  
BOX 10933  
Erie, PA 16514

\*\*\*\*\*

DHA HOBBY CRAFTS  
5204 Midmoor Rd  
Monona, WI 53716

# \*\*RETAILERS\*\*

\*\*\*\*\*

ELLIAM ASSOCIATES  
24000 Bessemer St.  
Woodland Hills, CA 91367  
818/348-4278

CP/M software for ADAM.

\*\*\*\*\*

EVE ELECTRONICS SYSTEMS  
2 Vernon St. Suite 404  
Framingham, MA 01701  
617/653-3003

Hardware, RS-232 Interface

\*\*\*\*\*

EVERYTHING'S ADAM  
BOX 579  
Gwynedd Valley, PA 19437  
215-643-7666

\*\*\*\*\*

EXTENDED SOFTWARE CO.  
11987 Ceedarcreek Dr.  
Cincinnati, OH 45240

Software, accepts new  
software for development.

\*\*\*\*\*

FISHER PRICE  
P.O. BOX 1327  
Cambridge, MA 02238  
617-494-1222

Learning Software

\*\*\*\*\*

FUTURVISION  
P.O. BOX 34  
N. Billerica, MA 01862  
617-663-8591

Sound & Music, utility  
software.

\*\*\*\*\*

HANDEL ENTERPRISES  
P.O. BOX 30756  
Honolulu, HI 96820

Software

\*\*\*\*\*

IMAGE MICROCORP  
P.O. Box 3761  
Cherry Hill, NJ 08034  
609-667-2526

Hardware, Software,  
accepts new software for  
development.

\*\*\*\*\*

IMAGIC  
981 University Ave.  
Los Gatos, CA 95030

ATT: Kathleen Booth  
Software.

\*\*\*\*\*

INTERNATIONAL COMPUTING  
P.O. BOX 176  
Patterson, NJ 28661

\*\*\*\*\*

INTERPHASE TECHNOLOGIES  
6391 F. Westminster Hwy  
Richmond, BC

Canada V7C 4V4

\*\*\*\*\*

J CHECK SOFTWARE  
BOX 345  
Millry, AL 36558

\*\*\*\*\*

J STANLEY CO.  
195 Reservoir St.  
Marbord, MA 01752

\*\*\*\*\*

KRAY  
17888 Maybury  
Fraser, MI 48026

\*\*\*\*\*

L.O.F.  
BOX 587  
York, PA 17405

Manual to make back-up  
& format cassettes.

# **\*\*RETAILERS\*\***

\*\*\*\*\*

M.W.RUTH CO.  
510 Rhode Island Ave.  
Cherry Hill, NJ 08002  
609-667-2526

Complete line of  
products:Hardware,Software,Books  
Etc..-Accepts software for  
development.(see ad-section)

\*\*\*\*\*

MAGIC WAND ENTERPRISES  
349 Lincoln St.  
Hingham, MA 02043

Building 63

\*\*\*\*\*

MARTIN CONSULTING  
94 Macalaster Bay  
Winnipeg, Manitoba  
R3T 2X5 Canada  
204/269-3234

Software-(see ad-section)

\*\*\*\*\*

MICRO 2  
P.O.BOX 5363  
Glendale, AZ 85312  
602-938-5640

\*\*\*\*\*

MICRO-FUN LAB  
2699 Skokie Valley Rd.  
Highland Park, IL 60035

Att:Susan Goldberg

\*\*\*\*\*

MMSG  
P.O. BOX 1112  
Broomfield, CO 80020-8112  
303-465-1561

back-up program  
(see ad-section)

\*\*\*\*\*

NICKELODEON GRAPHICS  
5640 W. Brown  
Glendale, AZ 85302

\*\*\*\*\*

PAPPAS PRODUCTS  
131 Dodge Street  
Beverly, MA 01915

\*\*\*\*\*

PARKER BROS.  
P.O.BOX 1012  
Beverly, MA 01915

\*\*\*\*\*

RANDALL MFG. CO.  
7800 S.W. 89th  
Portland, OR 97223

Accessories, printer  
quieter.

\*\*\*\*\*

REEDY SOFTWARE  
10085 60th St.  
Alto, MI 49302  
616-868-6588

Software-accepts new  
software for development. Business  
hours:10-6

\*\*\*\*\*

SAGE ENTERPRISES  
Rt 2 BOX 211 Scrivner Rd  
Russellville, MO 65074  
314-782-3448

Publishes "Expandable  
Computer News, Software packages,  
Public Domain packs.

\*\*\*\*\*

SPINNAKER  
One Kendall Square  
Cambridge, MA 02142  
617-494-1220

# \*RETAILERS\*

\*\*\*\*\*

STAR-BYTE, INC.  
2564 Industry Lane  
Norristown, PA 19403  
800-243-1515

Hours: 8:30-5 EST,  
Software. (see ad-section)

\*\*\*\*\*

STEVE JACOBY ENTERPRISES  
BOX 2498  
Clearwater, FL 33517  
813/595-0641  
6-9 PM (eastern)

Hardware, software,  
Books, etc...  
Accepts programs for  
development.

\*\*\*\*\*

SUNRISE SOFTWARE INC.  
8585 Stemmons Suite 912 S  
Dallas, TX 75247  
214-630-8171

Business hours:  
8:30-5:30

\*\*\*\*\*

SYDNEY DEVELOPING CORP.  
15-99 Fifth Ave.  
OTTAWA, ONTARIO,

Canada K1S 5K4

\*\*\*\*\*

THE ADAM DEPOT  
419 Ridgway Ave.  
Johnsonburg, PA 15845

Software, Hardware, Books,  
Supplies.

\*\*\*\*\*

TOM MADITZ  
114 E. 3rd St. Apt. 305  
Weston, WV 26452

Yahtzee Game (\$5)

\*\*\*\*\*

UNCLE ERNIE'S  
279 Eastholm  
Akron, OH 44312

Utility Software, Data  
paks. (see ad-section)

\*\*\*\*\*

VICTORY SOFTWARE  
2564 Industry Lane  
Norristown, PA 19403

\*\*\*\*\*

VIDEO TAKE-OUT  
12115 Magnolia #126  
North Hollywood, CA 91607  
800-228-1336

Hours: 9-5 Pacific Time,  
Software, Supplies, Books.

\*\*\*\*\*

VIDSKI  
894 INWOOD Pl.  
Rahway, NJ 07065



# the ADAM™ Resource

P.O. BOX 90  
SEELYVILLE, INDIANA 47878



## SECTION FOUR (#4)

# BOOKS & PUBLICATIONS

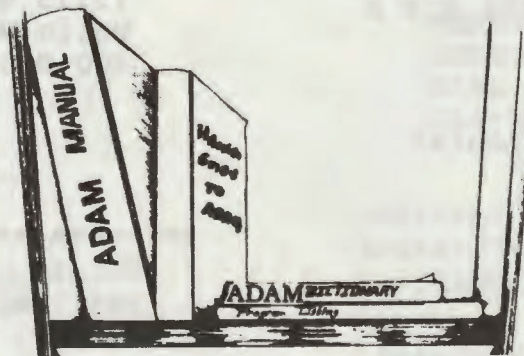

IN THIS SECTION YOU WILL FIND A LISTING OF BOOKS, JOURNALS, AND OTHER PUBLICATIONS AVAILABLE SPECIFICALLY FOR ADAM

YOU WILL ALSO FIND LISTINGS OF GENERAL COMPUTER PUBLICATIONS WHICH CAN ALSO BENEFIT ADAM OWNERS.

IF YOU BECOME AWARE OF A WORTHWHILE PUBLICATION OF INTEREST TO ADAM OWNERS (ONE OF COURSE NOT LISTED HERE) PLEASE DROP US A LINE AT: THE ADAM RESOURCE  
DEPT. 40 BOX 90  
SEELYVILLE, IN 47878

....OR IF YOU PUBLISH A NEW PUBLICATION...SEND US A COPY AND WE'LL INCLUDE IT IN THIS LISTING AS WELL AS THE NEW PRODUCT REVIEW SECTION OF OUR NEXT EDITION. THANKS!



# **\*\*PUBLICATIONS\*\***

- \*\*\*\*1ST BOOK OF ADAM (SMART BASIC)\*\*\*\* QUE-10.95 ( )
- \*\*\*\*2ND BOOK OF ADAM (SMART WRITER)\*\*\*\* QUE-8.95 ( )
- \*\*\*\*32 BASIC PROGRAMS FOR THE ADAM\*\*\*\* DILITHIUM PRESS-36.00 (4 DATA PACKS INCLUDED.)
- \*\*\*\*A HACKER'S GUIDE TO ADAM\*\*\*\* PETER & BEN HINKLE-12.95 (ADD 5.00 FOR TAPE WITH PROGRAMS ALREADY ON IT. EXCELLENT TECHNICAL SOURCE FOR ADAM.)
- \*\*\*\*ADAM TECHNICAL JOURNAL \*\*\*\* SERENDIPITY PUB.-\$18/yr (BiMONTHLY TECHNICAL JOURNAL.P.O. BOX 07592,MILWAUKEE, WI 53207.)
- \*\*\*\*ADAM USERS GUIDE \*\*\*\* BRADY-15.95 ( )
- \*\*\*\*ADAM'S COMPANION \*\*\*\* AVON BOOKS-9.95 (FOR ADAVANCED APPLICATIONS IN PROGRAMMING.BE SURE TO GET THE REVISED EDITION.BY BENSON & ROCHESTER.)
- \*\*\*\*ADAM:AN INTRO TO THE OPERATING, BASIC ETC\*\*\*\* BRADY-17.95 (ADAM: AN INTRODUCTION TOTHE OPERATING, BASIC PROGRAMMING, AND APPLICATIONS is full title)
- \*\*\*\*AUGMENT \*\*\*\* ADAM USER' GROUP-\$12/yr (BiMONTHLY NEWSLETTER OF THE 'ADAM USERS' GROUP' (A NATIONAL GROUP) OPPOX. CIRCULATION 5000)SEE AD-SECTION FOR DETAILS))
- \*\*\*\*COLECO ADAM ENTERTAINER \*\*\*\* OSBORN/MCGRAW HILL-12.95 ( )
- \*\*\*\*COMPUSERVE STARTER KIT \*\*\*\* COMPUSERVE-24.00 (5 FREE HOURS OF CONNECT TIME WITH PERSONAL ID NUMBER AND PASSWORD. MODEM REQUIRED.)
- \*\*\*\*COMPUTER ENTERTAINER \*\*\*\* COMPUTER ENTERTAINER-\$30/yr (MONTHLY REVIEW NEWSLETTER.(INDEPENDENT)COVERS SEVERAL COMPUTERS,INCLUDING ADAM EVERY MONTH. COMPUTER ENTERTAINER,PO BOX 4702,N.HOLLYWOOD,CA 91607)
- \*\*\*\*EXPANDABLE COMPUTER NEWS \*\*\*\* SAGE ENTERPRISES-\$12/yr (Bi-Monthly independent newsletter for ADAM owners.(SEE AD-SECTION FOR DETAILS))
- \*\*\*\*FAMILY COMPUTING MAGAZINE\*\*\*\* -\$16/yr (P.O.BOX 2512,Boulder,CO 80321)
- \*\*\*\*FLIPTRACK LEARNING SYSTEM\*\*\*\* LEARNING EXPRESS-24.95 (INCLUDEDS 2 SPOKEN VOICECASSETTS AND QUICK REFERENCE GUIDE.)
- \*\*\*\*HOW TO DOCUMENT YOUR SOFTWARE\*\*\*\* TAB BOOKS INC.- (BY BARABARA SPEAR- THIS BOOK WAS WRITTEN USING AN ADAM COMPUTER.-BLUE RIDGE SUMMIT, PA 17214)

# **\*\*PUBLICATIONS\*\***

- \*\*\*\*HOW TO USE THE COLECO ADAM\*\*\*\* DILITHIUM PRESS-5.95 ( )
- \*\*\*\*INLAND EMPIRE ADAM USER GROUP NEWSLETTER\*\*\*\* INLAND EMPIRE USER GROUP-?  
(MONTHLY NEWSLETTER.CONTACT MIKE & PAULA SMITH,6644 SEINE AVE,HIGHLAND, CA  
92346)
- \*\*\*\*JOY OF BASIC FOR THE ADAM\*\*\*\* BRADY-14.95 ( )
- \*\*\*\*L.O.F. COMMUNICATIONS \*\*\*\* L.O.F. York,Pa.-\$7.95 (ADAM DIGITAL DATA  
PACK FORMAT AND DUPLICATION MANUAL.)
- \*\*\*\*LEARNING TOGETHER WITH ADAM\*\*\*\* -9.95 (HOW TO USE THE COMPUTER TO  
EDUCATE CHILDREN. COVERS SMARTWRITER, BASIC, AND SMARTLOGO.)
- \*\*\*\*PROGRAMMING ADAM:HOME APPLICATIONS IN BASC\*\*\*\* BANBURY-11.95 ( )
- \*\*\*\*SMART BASIC FOR THE ADAM\*\*\*\* BRADY-11.95 ( )
- \*\*\*\*SPRITE CHASER \*\*\*\* #1 ADAM USERS' GROUP-\$15/yr (NEWSLETTER OF #1 ADAM  
USERS' GROUP (NATIONAL GROUP) WRITE:#1 ADAM USERS' GROUP.PO BOX 3761-ATT. JAY  
FORMAN,CHERRY HILL, NJ 08034(SEE-AD-SECTION))
- \*\*\*\*THE ADAM HOME COMPUTER \*\*\*\* BRADY COMMUNICATIONS-\$12.95 (INTRODUCTION  
TO SMARTBASIC AND APPLICATIONS.WRITTEN BY ARRY JOEL GOLDSTEIN)
- \*\*\*\*SYNTAX \*\*\*\* 1st CANADIAN AUG- (BiMONTHLY PUBLICATION OFTHE FIRST  
CANADIAN ADAM USERS' GROUP.-P.O.BOX 547 VICTORIA STATION,CANADA H3Z 2Y6.)
- \*\*\*\*THE ADAM-X-CHANGE\*\*\*\* (MONTHLY NEWSLETTER WRITTEN BY  
ADAM OWNERS. PROMOTES AN X-CHANGE OF IDEAS. WRITE: THE  
ADAM-X-CHANGE, 12863 WASHBURN, WOLCOTT, N.Y. 14590.



**DON'T LET THE NEXT EDITION OF THE ADAM RESOURCE DIRECTORY  
MISS YOU!!!!!!!!!!!!!!**

# the ADAM<sup>TM</sup> Resource

P.O. BOX 90  
SEELYVILLE, INDIANA 47878



## SECTION FIVE (#5)

# USER GROUPS

IN THIS SECTION WE HAVE COLLECTED INFO ABOUT USER GROUPS ACROSS THE COUNTRY IN WHICH WE HAVE BEEN INFORMED. WE HAVE ATTEMPTED IN ALL CASES TO PROVIDE INFO SUCH AS DUES, PUBLICATIONS, WHERE THEY MEET & WHEN. WE HAVE CONTACTED BY LETTER EACH GROUP, HOWEVER, A NUMBER OF GROUPS DID NOT SUPPLY THE INFO TO US SO WE CAN ONLY LIST WHAT WE KNOW.

WE ENCOURAGE YOU TO CONTACT OTHER USER GROUPS AND EXCHANGE IDEAS. YOUR GROUP CAN BE OF GREAT HELP TO OTHERS IF YOU WILL JUST OPEN THE LINES OF COMMUNICATION.

### TO USER GROUPS:

IF YOU ARE NOT LISTED HERE, OR NEED TO MAKE A CHANGE IN YOUR INFO, DROP US A CARD WITH YOUR INFO TO:

THE ADAM RESOURCE  
DEPT. 50 BOX 90  
SEELYVILLE, IN 47878

### ALSO...

IF YOU PUBLISH A NEWSLETTER, WE'D APPRECIATE BEING PUT ON YOUR MAILING LIST. IN FUTURE ADDITIONS WE WILL BE SHARING "USER GROUP NEWS". THANKS!!!

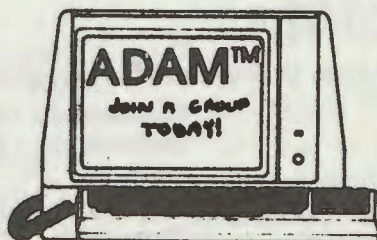

# \*\*USER GROUPS\*\*

\*\*\*\*\*#1 ADAM USER'S GROUP\*\*\*\*

Cherry Hill, NJ 08034\*607-667-2526  
Jay H. Forman-

National group.

Quarterly newsletter. Dues \$15/yr.  
Meets Cherry Hill, NJ. 800 members.  
P.D. Library.

\*\*\*\*\*A. W. AUG\*\*\*\*

Falls Church, VA 22042\*703-241-0540  
Michael King Sr-

Quarterly newsletter.

Dues \$15/yr. Meets Silver Spring,  
MA and Tysons corner, VA. P.D.  
Library. 40 members.

\*\*\*\*\*ADAM AND EVE\*\*\*\*

Olympia, WA 98501\*206-943-6005  
E. Fehring-

\*\*\*\*\*ADAM MICROHACKERS\*\*\*\*

New York, NY 11206\*  
David Kennedy-

\*\*\*\*\*ADAM NETWORK\*\*\*\*

East Detroit, MI 48021

\*\*\*\*\*ADAM USER'S GROUP, INC.\*\*\*\*

Lynbrook, NY 11563

National group - approx.

5000 members

\*\*\*\*\*ADAM USER'S OF EL PASO\*\*\*\*

El Paso, TX 79912  
Dick Lewin-

\*\*\*\*\*ADAM WASHINGTON D.C\*\*\*\*

Vienna, VA 22180\*Jim Tyson

\*\*\*\*\*ALAN L. TAYLOR\*\*\*\*

Stewartville, MN 55976\*507-533-8415

call after 6 PM

\*\*\*\*\*BAY REGION ADAM INFO\*\*\*\*

San Francisco, CA 94131\*415-285-3007  
George Havach-

Group known as BRAIN.

No dues. Informal network.

\*\*\*\*\*BELEVILLE AUG\*\*\*\*

Bellevue, NE 68005\*402-291-4405  
Norman Castro-

\*\*\*\*\*BILL & NANCY RAHN\*\*\*\*

Afton, MN 55001\*612-436-6577

\*\*\*\*\*CENTRAL CALIF. ADAM USERS\*\*\*\*

Madera, CA 93637\*299-661-8290  
James Turner, J.-

Meets 1st Fri/Mo. Dues

\$10/yr. 12 members.

\*\*\*\*\*CIMINO PIZZA & REST.\*\*\*\*

Rockford, IL 16111

contact Donald Rob

Lager for info

\*\*\*\*\*CLARESHOLM ADAM USERS\*\*\*\*

Claresholm, AB,  
Derek Townsend-

Claresholm, AB Canada

TOLOTO. Dues-Free. 12 members. BBS-  
404-445-8785.

\*\*\*\*\*DANNY LEVITT\*\*\*\*

Tucson, AZ 85730\*602-790-9678

\*\*\*\*\*DENNIS A. JUREWICZ\*\*\*\*

Pekin, IL 61554

\*\*\*\*\*DEREK TOWNSEND\*\*\*\*

Claresholm,

Alberta, Canada TOL OTO

\*\*\*\*\*DONALD R. LAGER\*\*\*\*

Rockford, IL 61111\*815-877-7786

\*\*\*\*\*DOWNTOWN MINNEAPOLIS AUG\*\*\*\*

Minneapolis, MN 55408

Thomas Gilmore-

Meets 9:30 AM first Wed.

of each month. 6-members, meets at  
"Donna's Place" cafeteria downtown.

\*\*\*\*\*Dr. STEVE HARRIS\*\*\*\*

Columbus, OH 43215\*614-221-2049

# \*\*USER GROUPS\*\*

\*\*\*\*\*DWIGHT WAGGENER\*\*\*\*

Marietta, GA 30066\*404-928-1016

\*\*\*\*\*EAST TEXAS ADAM USERS\*\*\*\*

Marshall, TX 75670  
Jerry Pritchard-

\*\*\*\*\*FIRST CANADIAN AUG\*\*\*\*

Victoria Station,

Westmount,  
Quebec H3Z 2Y6

\*\*\*\*\*FRANK FLEICH\*\*\*\*

Corona, CA 91719

\*\*\*\*\*GARY HILL\*\*\*\*

Chapel Hill, NC 27514\*919-968-0299

\*\*\*\*\*GENESEE VALLEY ADAM USES\*\*\*\*

Silver Springs, NY 14550  
Don Zimmerman-

\*\*\*\*\*GREATER CINCINNATI AUG\*\*\*\*

Alexandria, KY 41001  
Keith Bowman-

\*\*\*\*\*H.A.A.U.G.c/Thomas Rutin\*\*\*\*

Texas City, TX 77590  
Thomas Rutan-

\*\*\*\*\*HAMILTON-NIAGRA AUG\*\*\*\*

3-125 Livingston Ave.  
Grimsby, Ontario,  
Canada L3M 4S5

\*\*\*\*\*HARVEY KLEIN\*\*\*\*

Los Angeles, CA 90035\*213-553-1062

\*\*\*\*\*HAWAII AUG\*\*\*\*

Honolulu, HI 96818\*808/422-4019  
Harlan Fletcher-

\*\*\*\*\*HERITAGE ADAM CLUB\*\*\*\*

Omaha, NE 68102\*402-342-2565  
Eileen Smith-

\*\*\*\*\*HOUSTON USER'S GROUP\*\*\*\*

Humble, TX 77346  
Russell Clinton-

\*\*\*\*\*INLAND EMPIRE ADAM USER\*\*\*\*

Highland, CA 92346\*714-862-5807

INLAND ADAM USERS GROUP

contact Mike & Paula Smith.Meets 11-  
3 PM each 3rd Sat.,45 members,no  
reg. dues,meets at 401 Arrowhead  
Ave., San Bernardino,CA (Public  
Library)

\*\*\*\*\*J.A. GIRARD\*\*\*\*

Langevin Sud,

Alma, Quebec,Canada G8B

6B1

\*\*\*\*\*LAS VEGAS ADAM CLUB\*\*\*\*

Las Vegas, NV 89103  
Al Roginsky-

P.O. BOX 81146

Las Vegas, NV 89103

meets every other

thursday 7-12 PM dues:\$10/yr

8 members. (SEE AD-SECTION)

\*\*\*\*\*METRO ADAM USER'S GROUP\*\*\*\*

New York, NY 10031\*212-208-0645  
Russell Willias-

9am-5pm,M-F

\*\*\*\*\*METRO TORONTO AUG\*\*\*\*

260 Adelaide St.East,

Toronto,Ontario M5A 1N0

\*\*\*\*\*MIKE LAURIER\*\*\*\*

Anjou, Quebec, Canada HIK

3G6

\*\*\*\*\*NIAD\*\*\*\*

Lisle, IL 60532\*312-961-3521

Lyle Marschand-

monthly newsletter,

buying service. Dues \$18/yr. P.D.

Library. 200 members.

\*\*\*\*\*NORTHWEST ADAM USER'S GP\*\*\*\*

Kent, WA 98042\*206-886-1167

Valorie Zimmerman

# **\*\*USER GROUPS\*\***

## **\*\*\*\*\*OMAHA ADAM USERS CLUB\*\*\*\***

Bellevue, NE 68005\*402-291-4405  
Norman Castro-

Meets every 2 mo.

Bellevue Public Library 1003  
Lincoln Rd. Dues \$15/yr. 42 members.

## **\*\*\*\*\*PUGET SOUND\*\*\*\***

Kent, WA 98042\*206-886-1167  
V. Zimmerman-

Meets 3rd Thurs.

Federal Way Library 848 S. 320th,  
Federal Way, WA 206-839-0257. Dues  
are contributions.

## **\*\*\*\*\*RICHARD BAINES\*\*\*\***

Anchorage, AK 99507\*

## **\*\*\*\*\*ROBERT DUNSTAN\*\*\*\***

Ajax, \*

Ontario, Canada  
LIS 1K2

Compuserve ID#75026,3435

## **\*\*\*\*\*ROBERT LENNES\*\*\*\***

Dolton, IL 60419\*312-841-5776

## **\*\*\*\*\*ROBERT MARENTES\*\*\*\***

Phoenix, AZ 85021\*

## **\*\*\*\*\*ROBERT R. MARENTES\*\*\*\***

Phoenix, AZ 35653\*

## **\*\*\*\*\*SEATTLE-TACOMA ADAM USER\*\*\*\***

Seattle, WA 98126\*206-938-5276  
Barbara Duncan-

## **\*\*\*\*\*SOUTHERN CALIF.ADAM USER\*\*\*\***

Alta Loma, CA 91701\*714-989-1394  
Brian Stranaham-

## **\*\*\*\*\*THE (717) ADAM USERS\*\*\*\***

Bloomsburg, PA 17815\*  
Steve Chamberla-

Steve Chamberlain

## **\*\*\*\*\*TOM RUTAN\*\*\*\***

Texas City, TX 77590\*

## **\*\*\*\*\*TOM STANHOPE\*\*\*\***

Houston, TX 77080\*713-460-9734

## **\*\*\*\*\*TRI-ANGLE ADAM USERS\*\*\*\***

Chapel Hill, NC 27514\*919-968-0299  
Gary Hill-

## **\*\*\*\*\*USNH\*\*\*\***

FPO Seattle, WA 98778\*  
David Sandahl-

## **\*\*\*\*\*VICTOR L. WATFORD\*\*\*\***

Russellville, AL 35653\*

## **\*\*\*\*\*VICTOR L. WATFORD\*\*\*\***

Russellville, AL 35653\*205-332-6069

## **\*\*\*\*\*WINNIPEG AUG\*\*\*\***

Winnipeg, \*  
David Fordyce-

Manitoba,  
Canada, R2K 1X5

## **\*\*\*\*\***

FIRST CANADIAN A.U.G.  
P.O. Box 547 Victoria Station  
Westmount, Quebec, Canada  
H3Z 2Y6

Publishes "SYNTAX" newsletter  
by-monthly. 1000+ members.call  
514/487-0110, Mon, Tues or Wed 9-12 AM  
EDT.

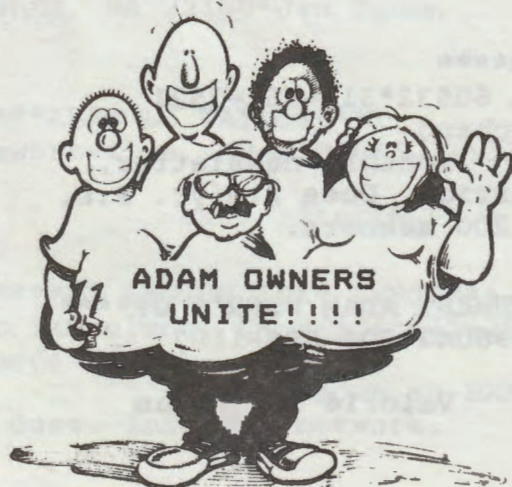

# the ADAM™ Resource

P.O. BOX 90  
SEELYVILLE, INDIANA 47878



## SECTION SIX (#6)

# ADAM USERS

THIS SECTION IS A COLLECTION OF ADAM USERS AS THEY HAVE SUPPLIED US WITH THEIR PERSONAL INFORMATION. SOME OF THE ADDRESSES ARE NOT ENTIRELY COMPLETE BECAUSE THEY WERE SUPPLIED TO US THAT WAY, HOWEVER, WE DECIDED TO INCLUDE THEM IN THE LISTING.

WE EXPECT THIS LISTING TO GROW A LOT FOR FUTURE EDITIONS. IF YOU ARE NOT LISTED HERE AND WISH TO BE, WRITE TO US AT:

THE ADAM RESOURCE  
DEPT. 60 BOX 90  
SEELYVILLE, IN 47878

SOME OF THE ENTRIES SUPPLIED US WITH THEIR AREAS OF INTEREST OR INDICATED IF THEY OWNED A DISC DRIVE ETC... THIS INFO HAS BEEN CODED FOR SPACE SAKE. THE CODING USED IS AS FOLLOWS:

- 1- OWNS A MODEM
- 2- OWNS A DISC DRIVE
- 3- BASIC
- 4- LOGO
- 5- CPM
- 6- MACHINE
- 7- GRAPHIC GAMES
- 8- TEXT GAMES
- 9- EDUCATIONAL
- 10-BUSINESS
- 11-WORD PROCESSING
- 12-UTILITIES



# \*\*ADAM USERS\*\*

\*\*\*\*\*

ANDRESEN, Leonard  
15803 Valley St  
Omaha, NE  
\*\*\*-333-1825  
2,3,4,5,6,7,8,9,10,11-AGE:36

\*\*\*\*\*

ARCORACI, Dennis  
  
Alex, VA  
  
3,4,9,10,11-AGE:45

\*\*\*\*\*

AZEVEDO, Frank  
2733 Magnet St.  
N. Las Vegas, NV 89030  
702-870-6640  
1,3,4,5,6,7,9,12-AGE:38

\*\*\*\*\*

BADEAUX, Jon  
12115 Magnolia #126  
N. Hollywood, CA  
  
1,2,3,4,5,6,7,8,9,10,11,12-AGE:

\*\*\*\*\*

BAER, Fred  
PO Box 5401  
San Mateo, CA 94402  
415-345-4114  
1,2,4,5,7,8,9,10,11,12-AGE:45

\*\*\*\*\*

BAER, Bridget  
853 Vega Circle  
Foster City, CA 94494  
415-593-5973  
1,2,3,4,7,8,9,11-AGE:15

\*\*\*\*\*

BANAS, Steve  
3603 Katie Dr  
C. Bluffs, IA 51501  
\*\*\*-366-1768

\*\*\*\*\*

BANKS, Sherry  
  
Ft Belvoir, VA  
  
9,10,11

\*\*\*\*\*

BARANSKI, Elisa  
2418 California St  
Berkeley, CA 94704  
  
9,10,11-AGE:25

\*\*\*\*\*

BARANSKI, John  
PO Box 8381  
San Diego, CA 92102  
  
9,10,11,12-AGE:55

\*\*\*\*\*

BELLINETTI, Frank  
  
Springfield, VA

\*\*\*\*\*

BERGER, J.L.  
  
Alex, VA

\*\*\*\*\*

BERSANE, John  
615 N. 38th St  
C. Bluffs, IA  
\*\*\*-328-1032  
2,3,4,5,7,9,10,11,12-AGE:32

\*\*\*\*\*

BROCH, Donald  
340 Royal Ct.  
Princeton, WV  
  
3,5,7,9,10,11,12

\*\*\*\*\*

BROWN, Richard  
13547 Currey Lane  
Chantilly, VA 22021  
  
1,2,3,5,6,7,8,9,10,12-AGE:37

\*\*\*\*\*

BROWN, William  
  
Hayettesville, MD  
  
7,8,11



# \*\*ADAM USERS\*\*

\*\*\*\*\*

BRUNING, Shirley  
10833 X St.  
Omaha, NE  
\*\*\*-339-3317  
3,4,8,9,10,11,12-AGE:45

\*\*\*\*\*

BURROWS, Keith  
Rt. 51 Box 472P  
Terre Haute, IN 47805

1,2,3,9,10,12-AGE:31

\*\*\*\*\*

BUSBY, John II  
6634 SW 41st St  
Davie, FL 33314  
  
Compuserve ID #74726,1056

\*\*\*\*\*

BUTTS, Robert L.  
9418 W. River Rd.  
Minneapolis, MN 55444

2,3,4,7,8,11

\*\*\*\*\*

CASTRO, Norman  
809 W. 33rd Ave  
Bellevue, NE 68005  
\*\*\*291-4405  
2,3,4,5,6,7,8,9,10,11,12-AGE:51

\*\*\*\*\*

CONNELLY, Ralph  
7104 86th St #326  
LaVista, NE 68128  
\*\*\*-339-0380  
-AGE:

\*\*\*\*\*

COOKSEY, Ronald  
831 N. San Antonio  
Pomona, CA 91767  
  
1,2,3,4,5,6,7,8,9,10,11,12-AGE:27

\*\*\*\*\*

DANIELS, Moon  
  
Dale City, VA  
703-680-2228  
1,2,3,4,5,6,7,8,9,10,11,12-AGE:32

\*\*\*\*\*

DARANET, Michael  
28 Viola St.  
Winnipeg,  
MB Canada R2V 3B9  
1,3,4,5,7,8,10,12-AGE:

\*\*\*\*\*

DRIESSEL, Berkley  
2555 Homestead Ave Apt #18  
Santa Clara, CA 95051

9,11,12-AGE:47

\*\*\*\*\*

DRIVER, Larry  
4520 Knoll Dr  
Dale City, VA 22193  
703-520-9059  
1,3,4,5,6,7,8,9,10,11,12-AGE:44

\*\*\*\*\*

DUNCAN, Barbara  
3727 34th SW  
Seattle, WA 98126  
206-938-5276  
2,3,7,8,9,10,11,12

\*\*\*\*\*

EHRANN, Rick  
  
Washington DC,  
  
3,4,7,10,11,12-AGE:

\*\*\*\*\*

ENGLEHART, Mickey  
  
Baltimore, MD

\*\*\*\*\*

ESTRADA, Joseph  
4672 Harrison St  
Omaha, NE 68157  
\*\*\*-731-0363  
3,4,7,8,9,10,11,12-AGE:11

\*\*\*\*\*

FEE, Bill  
729 E.Emerson Ave.  
Orange, CA 92665  
  
1,2,3,4,5,6,7,8,9,10,11,12-AGE:63

# \*\*ADAM USERS\*\*

\*\*\*\*\*

FORMAN, Jay H.  
510 Rhode Island Ave  
Cherry Hill, NJ 08002  
609-667-2526  
1,2,3,4,5,6,7,8,9,10,11,12-AGE:44

\*\*\*\*\*

FRAZIER, Randy  
4803 S 22nd St  
Omaha, NE 68107  
\*\*\*-733-7065  
3,4,6,7,9,11,12-AGE:27

\*\*\*\*\*

FREDRICKS, Neal  
3125 Brooklawn Terr.  
Chevy Chase, MD 20815  
1,2,3,4,5,6,7,8,9,10,11,12-AGE:15

\*\*\*\*\*

GARNETT, Mary  
Rockville, MD

\*\*\*\*\*

GAVIO, John  
2441 Hershey Rd  
Erie, PA 16509  
\*\*\*-864-0809  
1,3,5,6,7,8-AGE:

\*\*\*\*\*

GILMORE, Thomas C.  
1424 W. 33rd St.  
Minneapolis, MN 55408  
1,2,3,4,7,8,9,10,11,12-AGE:

\*\*\*\*\*

GREEN, Mary Kay  
1006 Howard St  
Omaha, NE 68102  
\*\*\*-342-4041

\*\*\*\*\*

GREGORY, Shirley  
Annandale, VA

\*\*\*\*\*

GRICKO, Charles  
41 Longview Trail  
Denville, NJ 07834  
Also Christopher Gricko

\*\*\*\*\*

HALELY, Sharon

\*\*\*\*\*

HALL, John  
2869 March Circle  
Omaha, NE 68105  
\*\*\*-291-5998  
3,5,6,7,8,9,10,11,12-AGE:37

\*\*\*\*\*

HAMMACK, Jim  
RT 4  
Fairfield, IL 62837

\*\*\*\*\*

HAVACH, George A.  
550 27th St #202  
San Francisco, CA 94131  
415-282-3056  
1,2,3,4,5,6,7,11,12-AGE:40

\*\*\*\*\*

HEIMANN, Dan  
1541 S. 25th St  
Omaha, NE 68105  
\*\*\*-342-3217  
3,4,5,7,8,9,10,11,12-AGE:35

\*\*\*\*\*

HENDERSHOT, Douglas  
Ft. Belvoir, VA

\*\*\*\*\*

HENDRICKS, Adrian  
9932 Lindel Lane  
Vienna, VA 22180

1,2,3,5,10,11,12-AGE:46

# \*\*ADAM USERS\*\*

\*\*\*\*\*

HINTZ, Dan  
7716 Leaf Plum Dr  
LaVista, NE 68128  
\*\*\*-339-3129  
3,4,5,7,8,9,10,11,12-AGE:26

\*\*\*\*\*

HOOK, Larry  
  
Alex, VA  
  
1,3,4,7,8,9,11-AGE:

\*\*\*\*\*

HOWGED, James  
6541 Va Hills Ave  
Alex, VA 22310  
  
3,4,6,7,9,10,11-AGE:

\*\*\*\*\*

IMDIEKE, Mary Ellen  
1540 128th Ave.  
Blaine, MN 55434  
  
3,4,7,8,9,10,11,12-AGE:

\*\*\*\*\*

INGERSKY, Don  
  
Woodbridle, VA  
703-441-8218  
1,2,3,4,5,6,7,8,9,10,11,12-AGE:32

\*\*\*\*\*

ITSON, William  
4485 Pennwood Ave Apt. #334  
Las Vegas, NV  
702-367-0970  
1,3,4,7,9,10,12-AGE:26

\*\*\*\*\*

JERABEK, Dave  
13436 Spring St  
Omaha, NE 68114  
\*\*\*-333-9094  
3,4,5,7,8,9,11-AGE:36

\*\*\*\*\*

JESSEN, Linda  
5278 Sunnyside Rd.  
Mands View, MN 55112  
  
3,4,7,8,9,10,11,12-AGE:

\*\*\*\*\*

JOHN, Daniel  
  
New Carlton, MD  
301-552-1715  
2,3,7,9,11-AGE:

\*\*\*\*\*

JOHNSON, Mary Ann  
13124 Burdette Circl  
Omaha, NE 68164  
\*\*\*-496-0386  
3,4,7,8,9,11-AGE:37

\*\*\*\*\*

JOHNSTON, David  
Box 1042  
Claresholm,  
AB Canada TOL OTO  
3,7,8,11-AGE:15

\*\*\*\*\*

KEITH, Jack  
  
Falls Church, VA

\*\*\*\*\*

Kiessling, Linda  
  
Alex, VA  
\*\*\*\*\*  
KING, Michael V.  
6702 James Lee St.  
Falls Church, VA 22042  
703-241-0540  
1,2,3,4,5,6,7,9,10,11,12-AGE:29

\*\*\*\*\*

KING, Karen  
  
Manassas, VA

\*\*\*\*\*

KLINGLER, Rodney  
407 E. 11th St  
Fremont, NE 68025  
\*\*\*-727-7256  
3,4,7,8,9,10,11,12-AGE:38

\*\*\*\*\*

L'TTERAULT, Perry  
61 Cosby Ave  
St. Catharines,  
ON Canada L2M 5R7  
2,3,4,5,7,8,9,10,11,12-AGE:

# \*\*ADAM USERS\*\*

\*\*\*\*\*

LAKE, Donald  
6301 Brandywine Way  
Las Vegas, NV  
702-870-6640  
2,3,4,5,6,7,8,9,10,12-AGE:38

\*\*\*\*\*

LAUNDRE, T.H.  
Rt 2 Box 233  
Coldwater, MS 38618  
3,4,5,6,7,8,9,10,11,12-AGE:

\*\*\*\*\*

LEVY, Peter  
  
Columbia, MD

\*\*\*\*\*

LIPCOMB, David  
  
Brayntown, MD  
301-274-3550  
3,7,11-AGE:

\*\*\*\*\*

LOGAN, John  
1905 Thurston Av #6  
Bellevue, NE 68005  
\*\*\*-292-2373  
3,4,5,6,7,8,9,10,11-AGE:28

\*\*\*\*\*

LONG, Robert  
5070 River Glen Dr Apt #337  
Las Vegas, NV 89103  
702-873-5939  
3,4,6,7,8,9,12-AGE:33

\*\*\*\*\*

MACCARONI, Ron  
  
Springfield, VA  
3,7,9,11,12-AGE:

\*\*\*\*\*

MALONEY, Mark  
Box 181  
Claresholm,  
AB Canada TOL OTO  
3,4,7,8,12-AGE:15

\*\*\*\*\*

MAR, Gary  
4417 Hartwick  
College Park, MD 20740  
3-AGE:39

\*\*\*\*\*

MARTIN, Kathy  
1321 Englewood Dr  
Bellevue, NE 68005  
\*\*\*-292-3388

\*\*\*\*\*

MASON, Ralph  
  
Arlington, VA  
2,3,5,6,9,10,11,12-AGE:

\*\*\*\*\*

MAXWELL, Michael  
  
Springfield, VA

\*\*\*\*\*

MEDINA, Patty  
5002 N.W. 18th PL  
Gainesville, FL 32605  
904-378-5424  
Compuserve ID #72267,756

\*\*\*\*\*

MENSER, Todd  
3124 N 45th St  
Omaha, NE 68104  
\*\*\*-455-6088  
3,4,7,8,9,10,11,12-AGE:15

\*\*\*\*\*

MILLER, Collin  
  
Bethesoa, MD  
7,9,11-AGE:16

\*\*\*\*\*

MOHAMADI, Saleh  
  
Fairfax, VA

# \*\*ADAM USERS\*\*

\*\*\*\*\*

MORRIS, Tanya  
Fairmont Hts., MD  
7,8,11

\*\*\*\*\*

MORROW, Jim W.  
5352-B Comman Dr  
Eielson AFB, AK 99702

\*\*\*\*\*

MURPHY, Josephine  
Falls Church, VA  
2,3,5,7,8,11,12-AGE:48

\*\*\*\*\*

NETTE, Ken  
ATRS 109 MCDEC  
Quantico, VA 22134  
2,3,9,11-AGE:41

\*\*\*\*\*

NICHOL, Jim  
College Parke, MD  
-AGE:33

\*\*\*\*\*

OKELBERRY, Bart  
3756 Brentwood St  
Las Vegas, NV  
702-458-5840  
1,2,3,4,7-AGE:17

\*\*\*\*\*

OLSON, Mark  
31 Fairchild Circle  
CAFB, NE 68113  
\*\*\*-291-5956  
3,4,5,6,7,8,9,10,11,12-AGE:28

\*\*\*\*\*

OSBORNE, Mike  
Arlington, VA

\*\*\*\*\*

PARRISH, Lynn  
5424 N 65 St.  
Omaha, NE 68104  
\*\*\*-571-4620

\*\*\*\*\*

PURSGLOVE, David  
747 54th St  
Oakland, CA 94609  
6,7,10,11,12-AGE:49

\*\*\*\*\*

QUEEN, Mike  
PO Box 633  
Valley, NE 68064  
\*\*\*-359-2971

\*\*\*\*\*

RAUSCH, Bob  
407 Cascio Dr  
Bellevue, NE 68005  
\*\*\*-291-4234  
3,9,10,11-AGE:37

\*\*\*\*\*

REYNOLDS, David  
725 S. 7th St  
Terre Haute, IN 47807  
812-234-3461  
1,2,3,4,5,6,7,8,12-AGE:29

\*\*\*\*\*

ROGINSKY, Al  
4327 Thorndale PL  
Las Vegas, NV 89103  
702-873-5950  
1,2,3,5,6,7,8,12-AGE:39

\*\*\*\*\*

RUSSELL, John  
1220 Rogers Circle  
Pltsmth, NE 68048  
\*\*\*-296-3578

\*\*\*\*\*

SCHLAUTMAN, Larry  
RR 5 Box 64J  
C. Bluffs, IA 51501  
\*\*\*-322-1939

# \*\*ADAM USERS\*\*

\*\*\*\*\*

SCHLIFFKE, Warner  
6123 Ruggles St  
Omaha, NE 68104  
\*\*\*-451-8267  
3,5,6,7,10,11,12-AGE:42

\*\*\*\*\*

SEPPALA, Harvey  
6781 Greengrove Dr.  
Las Vegas, NV  
702-873-8633  
1,3,4,5,6,7,10,12-AGE:37

\*\*\*\*\*

SMITH, Phillip W.  
75 Bonner Rd  
OffuttAFB, NE 68113  
\*\*\*-292-0391  
3,4,5,7,9,10,11,12-AGE:33

\*\*\*\*\*

SMITH, Quinn S.  
PO Box 218  
Bellevue, NE 68005  
\*\*\*-291-6373  
3,5,9,10,11,12-AGE:60

\*\*\*\*\*

SMITH, Lee  
105 Donna Dr  
Terre Hill, PA 17581

\*\*\*\*\*

SMITH, Mike/Paula  
6644 Seine Ave.  
Highland, CA 92346  
1,2,3,4,5,6,7,8,9,10,11,12-AGE:33

\*\*\*\*\*

SNYDER, Robert  
3960 Flagstone Ct.  
St. Louis, MO 63033  
3,5,7,8,9,10,11,12-AGE:39

\*\*\*\*\*

SOPER, Gerald E.  
11965 S. 29th St  
Omaha, NE 68005  
\*\*\*-291-3193  
3,5,9,10,11,12-AGE:39

\*\*\*\*\*

STEVEN, Karen  
17704 Mill Creek Dr  
Derwood, Md 20855

3,8,9,11-AGE:49

Also Barbara Dinsenbacher age 16

\*\*\*\*\*

STEWART, Ronny  
P.O.Box 325  
Rialto, CA 92376

1,2,3,4,5,6,7,8,9,10,11,12-AGE:

\*\*\*\*\*

STRAUB, David  
Also Connie Straub  
Arlington, VA

3,5,6,9,11-AGE:30

\*\*\*\*\*

STROUP, Dick  
1123 Rosecrans Ave.  
Fullerton, CA 92633

1,2,5,11

\*\*\*\*\*

SWANSTOM, Bill  
13535 Fernando Ave.  
Apple Valley, MN 55124

3,4,5,6,7,8,9,10,11-AGE:

\*\*\*\*\*

TATUM, Bill  
Falls Church, VA  
3,4,7,9,11-AGE:55

\*\*\*\*\*

TAYLOR, Len  
9909 Pinkney St  
Omaha, NE 68134  
\*\*\*-571-7331

\*\*\*\*\*

TIRY, Gaylon  
1402 Pelton Ave  
Bellevue, NE 68104  
\*\*\*-291-3193  
3,4,5,6,7,8,9,10,11,12-AGE:41

# \*\*ADAM USERS\*\*

\*\*\*\*\*

TOMKIN, Bill  
RR 3 Box 67  
Atlantic, IA 50022  
712-243-5119

\*\*\*\*\*

WALSH, Al  
Box 189  
Gretna, NE 68028  
\*\*\*-332-3704

\*\*\*\*\*

TOWNSEND, Dereh  
Box 820  
Claresholm,

\*\*\*\*\*

WEBB, Stu  
925 Lumber Exchang  
, MN 55402

1,2,3,4,5,6,7,8,9,10,11,12  
AGE:15

3,4,7,8,11-AGE:

\*\*\*\*\*

TURNER, James Jr  
20110 Ave 19  
Madora, CA 93637

\*\*\*\*\*

WENDELL, Don

1,2,3,4,5,7,8,11,12-AGE:28

Washington DC,  
201-291-2717

1,2,3,4,5,6,7,8,9,10,11,12-AGE:

\*\*\*\*\*

TYSON, Jim  
1811 Saint Roman Dr.  
Vienna, VA 22180

\*\*\*\*\*

WIIG, Jeff  
6021 Franklin St  
Omaha, NE 68104

1,2,3,4,5,6,9,10,12-AGE:44

\*\*\*-553-0548

3,7,8,9,10,11,12-AGE:28

\*\*\*\*\*

TZOV, Nolan  
  
Aldelpai, MD

\*\*\*\*\*

WOOD, Stefan  
4229 Leland St  
Chevy Chase, MD 20815

-AGE:14

\*\*\*\*\*

ULRICH, Herman  
2117 Lincoln Ave  
Pltsmith, NE 68104  
\*\*\*-296-4185

\*\*\*\*\*

WOOD, Stefan  
  
Chevy Chase, MD

\*\*\*\*\*

YATES, John  
1200 S Arl. Ridge Rd  
Arlington, VA 22202

\*\*\*\*\*

VAN EVERA, Jim  
303 N. Queen St.  
Martinsburg, WV 25401

\*\*\*\*\*

WOODRUFF, Gary  
RT.7 Box 224  
Frankfort, IN 46041  
(317)379-221

1,2,3,9,10,11,12-AGE:

\*\*\*\*\*

Zimmerman, Valerie  
22607 SE 322nd St  
Kent, WA 98042  
206-886-1167

1,2,3,4,5,7,8,9,10,11,12-

\*\*\*\*\*

WADE, H.R. Jr.  
6015 Sprague St  
Omaha, NE 68104  
\*\*\*-451-8475

\*\*\*\*\*

YAHLE, George  
3110 JoAnn Ave  
Omaha, NE 68123  
\*\*\*-291-6443

10,11-AGE:62

\*\*\*\*\*

ZIMMERMAN, Donald  
5132 Jordan Rd  
Silver Springs, NY 14550  
716-493-5998

-AGE:45

# the ADAM<sup>TM</sup> Resource

P.O. BOX 90  
SEELYVILLE, INDIANA 47878



## SECTION SEVEN (#7)

# SERVICE INFO

IN THIS SECTION YOU WILL FIND:

1. WHAT TO DO INFO WHEN IT BREAKS DOWN
2. HONEYWELL SERVICE CENTERS
3. CARE TIPS TO AVOID ADAM BREAK DOWNS.

### WHAT TO DO WHEN IT BREAKS DOWN!

IT'S ALWAYS AN AGGRAVATING EXPERIENCE TO HAVE TO HAVE SOMETHING SERVICED, NOT TO MENTION THE INCONVENIENCE. SOMETIMES IT'S NECESSARY, AND SOMETIMES NOT. MORE OFTEN THAN NOT, THE PROBLEM CAN BE SOLVED IN HOME! HERE ARE SOME PRACTICAL STEPS TO FOLLOW WHEN YOU HAVE TROUBLE WITH YOUR ADAM.

1. REFER TO THE "ADAM SYSTEM CHECK-OUT AND TROUBLESHOOTING GUIDE". THIS BOOKLET WILL ELIMINATE MOST COMMON PROBLEMS OF A MINOR NATURE. IF YOU DON'T HAVE ONE, CALL COLECO & HAVE THEM SEND ONE OUT TO YOU.
2. IF YOU'VE TRIED EVERYTHING IN THE BOOKLET & STILL NO LUCK. CALL COLECO'S HOTLINE FOR FURTHER INSTRUCTIONS. BE PREPARED TO DESCRIBE THE DIFFICULTY CLEARLY. (1-800/842-1225 IN THE U.S. 1-800/361-2122 IN CANADA) CALL DURING DAY HOURS MON-FRI.
3. IF YOU NEED SERVICE, CALL ONE OF THE OFFICES LISTED HERE. THEY CAN TELL YOU APPROX. HOW MUCH IT WILL COST (IF YOU'RE OUT OF WARRANTY) AND MANY TIMES IT'S POSSIBLE TO TAKE THE UNIT IN YOURSELF AND WAIT FOR IT....BUT CALL FIRST. IT MAY BE NECESSARY FOR YOU TO SHIP IT IN. IN THAT CASE, BE PATIENT. ADAM WILL RETURN!



# \*\*SERVICE INFO\*\*

## TAKING CARE OF ADAM

- YOU CAN ELIMINATE 75% OF SERVICE NEEDS IF YOU DO THE FOLLOWING:
1. KEEP FOODS & LIQUIDS AWAY FROM ADAM. BREAK THOSE BAD HABITS! ADAM DOES NOT GET HUNGRY (FOR FOOD ANYWAY).
  2. USE A DRY CLOTH AND/OR AN AEROSOL DUST BLOWER TO CLEAN YOUR KEYBOARD, MEMORY CONSOLE, PRINTER & OTHER HARDWARE. DO IT PERIODICALLY. COMPUTERS HATE DUST!
  3. COVER ADAM WHEN NOT IN USE! BUY COVERS OR MAKE SOME...BUT COVER IT. DUST IS A BIG ENEMY OF ELECTRONICS!
  4. KEEP YOUR PRINTER COOL! INVEST IN A COMPUTER FAN TO SUCK OUT THE HOT AIR IF YOU USE YOUR ADAM FOR LONG PERIODS OF TIME.
  5. INVEST IN A VOLTAGE SPIKE ELIMINATOR. THIS WILL PROTECT YOUR ADAM FROM SUDDEN SURGES IN ELECTRICITY WHICH CAN CAUSE INTERNAL DAMAGE.
  6. WHEN LEAVING FOR SEVERAL DAYS, OR IN A STORM, UNPLUG ADAM. DON'T TAKE THE CHANCE OF LIGHTNING DAMAGE!

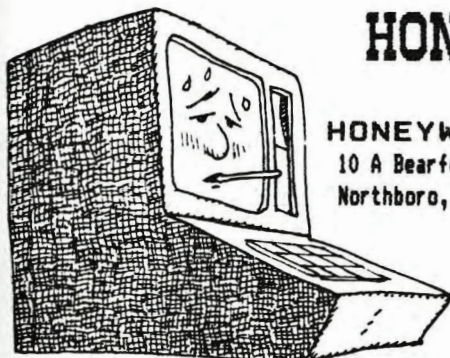

## HONEYWELL MAIL-IN LOCATIONS

**HONEYWELL**  
10 A Bearfoot Rd.  
Northboro, MA 01532

**HONEYWELL**  
338 East 12 Mile Rd.  
Madison Heights, MI 48071

**HONEYWELL**  
1120 N. Gilbert St.  
Anaheim, CA 92803

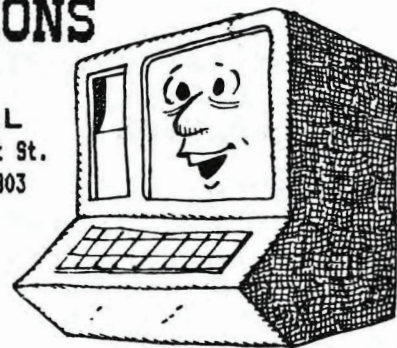

## WALK-IN LOCATIONS

**ARIZONA**  
**PHOENIX 602/862-3577**  
5115 N. 27th Ave.  
Phoenix, AZ 85017

**CALIFORNIA**  
**LOS ANGELES 213/533-8618**  
20600 Gramercy Place  
Torrance, CA 90501

**ANAHEIM 213/533-8618**  
1162 N. Gilbert St.  
Anaheim, CA 92803

**VAN NUYS 213/533-8618**  
1660 Sherman Way  
Van Nuys, CA 92803

**SAN FRANCISCO 415/467-6200**  
200 Valley Drive  
Suite 39  
Brisbane, CA 94005

**SAN DIEGO 619/576-1330**  
3860A Calle Fotunada  
San Diego, CA 92123

**COLORADO**  
**DENVER 303/779-6479**  
Suite 12C  
7100 East Bellview  
Englewood, CO 80111

**CONNECTICUT**  
**WINDSOR 203/688-7214**  
340 Broad Street  
Windsor, CT 06095

**FLORIDA**  
**MIAMI 305/592-5293**  
8685 NW 53rd Terrace  
Suite 106  
Miami, FL 33166

**GEORGIA**  
**ATLANTA 404/982-2320**  
2801 Buford Highway  
Atlanta, GA 30329

**HAWAII**  
**HONOLULU 808/836-2905**  
550 Paiea Street  
Honolulu, HI 96819

# **\*\*SERVICE INFO\*\***

## **WALK-IN LOCATIONS (CONTINUED)**

### **ILLINOIS**

**CHICAGO 312/671-1800 EXT. 509**  
4849 North Scott Street  
Schiller Park, IL 60176

### **LOUISIANA**

**NEW ORLEANS 504/456-7217**  
6620 Riverside Drive  
Metairie, LA 70003

### **MASSACHUSETTS**

**NEWTON HIGHLANDS 617/552-5880**  
141 Needham Street  
Newton Highlands, MA 02161

### **MICHIGAN**

**DETROIT 313/548-3550**  
338 East 12 Mile Road  
Madison Heights, MI 48071

### **MINNESOTA**

**EDINA 612/830-3899**  
7300 Metro Boulevard  
Edina, MN 55435

### **MISSOURI**

**ST. LOUIS 314/576-2606**  
12144 Lackland Road  
Creve Coeur, MO 63146-4087

### **NEW YORK**

**LONG ISLAND 516/334-1199**  
55 South Service Road  
Jericho, NY 11753

### **NEW YORK CITY 212/398-6474**

2 Penn Plaza - 11th Floor  
New York, NY 10001

### **ROCHESTER 716/424-2700**

100 Metro Park  
Rochester, NY 14623

### **NEW JERSEY**

**FAIRFIELD 201/575-7695**  
264 Passaic Avenue  
Fairfield, NJ 07006-2591

### **OHIO**

**CINCINNATI 513/745-7375**  
4350 Malsbary Road  
Cincinnati, OH 45242

### **CLEVELAND 216/459-6281**

925 Keynote Circle  
Brooklyn Heights, OH 44131

### **COLUMBUS 614/276-3164**

4189 Arling Gate Plaza  
Columbus, OH 43228

### **PENNSYLVANIA**

**PITTSBURGH 412/928-4337**  
5 Foster Plaza  
651 Holiday Drive  
Pittsburgh, PA 15220

### **PHILADELPHIA 215/839-6648**

One Bala Plaza  
Bala Cynwyd, PA 19004

### **TENNESSEE**

**MEMPHIS 901/345-6222 EXT. 197**  
2598 Corporate Avenue East  
Memphis, TN 38131

### **TEXAS**

**DALLAS 214/241-6046**  
13239 Valley Branch Lane  
Farmers Branch, TX 75234

### **HOUSTON 713/957-7530**

Suite 108  
4501 South Pinemont  
Houston, TX 77041

### **VIRGINIA**

**MCLEAN 703/827-3587**  
1766 Old Meadow Lane  
McClean, VA 22102

### **WASHINGTON**

**SEATTLE 206/233-2120**  
652 Industry Drive  
Tukwila, WA 98188

### **WISCONSIN**

**MILWAUKEE 414/784-6260 EXT. 403**  
150 North Sunnyslope Road  
Brookfield, WI 53005

**ADAM USERS ARE  
HAPPY PEOPLE!!!**



# the ADAM™ Resource

P.O. BOX 90  
SEELYVILLE, INDIANA 47878



## SECTION EIGHT (8#)

# TIP-SECTION

A COLLECTION OF PRACTICAL HELPS,  
IDEAS, AND SUGGESTIONS.

READ THROUGH THESE AND YOU MAY LEARN SOMETHING VALUABLE TO AID IN  
THE OPERATION OF YOUR ADAM, OR IN YOUR PROGRAMMING....  
IF YOU HAVE ANY GREAT TIPS, OR IDEAS TO SHARE WITH THE REST OF  
THE ADAM WORLD, SEND THEM TO US AND WE'LL BE SURE TO GIVE CREDIT  
WHERE CREDIT IS DUE.

SEND YOUR SUGGESTIONS TO:

THE ADAM RESOURCE  
DEPT. 80 BOX 90  
SEELYVILLE, IN 47878

THE FOLLOWING HAVE MADE  
CONTRIBUTIONS TO THIS  
SECTION:

NORMAN CASTRO  
LORETTA REYNOLDS  
JOHN BUSBY II  
& THE ADAM-  
RESOURCE STAFF

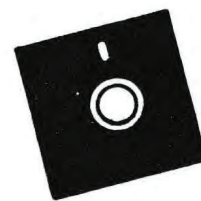

## HOW TO TELL YOUR VERSION\*\*

TO CHECK YOUR VERSION OF CPU, WHILE IN THE ELECTRONIC TYPEWRITER MODE PRESS CONTROL-R. LOOK AT THE SMARTKEY DISPLAY AT THE BOTTOM OF THE SCREEN AND YOU WILL SEE AN "R" FOLLOWED BY A NUMBER. IF YOUR NUMBER IS UNDER AN R79, IT HAS BUGS IN IT AND IT SHOULD BE TAKEN TO HONEYWELL FOR AN UPDATED VERSION.

TO CHECK YOUR SMARTBASIC VERSION. LOAD IN BASIC, THEN TYPE "PEEK 260" & PRESS RETURN. A NUMBER WILL APPEAR. IF ITS 79 OR ABOVE, IT'S OK. IF IT'S UNDER 79, GET IT REPLACED BECAUSE IT'S AN OLD VERSION. (SOME PROGRAMS AVAILABLE WILL NOT RUN WITH THE OLD VERSION)

TO CHECK YOUR FREE MEMORY SPACE...TYPE IN "PRINT FRE(0)" AND HIT RETURN. (25333 IS AVERAGE)

## THE ADAM PRINTER\*\*

KEEP THE TWO SILVER METAL GUIDES THAT THE PRINTER HEAD/RIBBON RIDES ON CLEAN BY WIPING THESE 2 GUIDES WITH A CLEAN LINT-FREE RAG AT LEAST ON A MONTHLY BASIS. AFTER CLEANING THE GUIDES SPRAY A LITTLE SILICONE LUBRICANT ON ANOTHER RAG THAN WIPE THIS SOLUTION ON BOTH GUIDES. THIS WILL KEEP YOUR PRINTED LISTS/COLUMNS/PARAGRAPHS AND LEFT MARGINS LINED UP OVER EACH OTHER WHEN PRINTED INSTEAD OF STAGGERED.

TO KEEP ADAM RUNNING FOR A LONGER PERIOD OF TIME WITHOUT "OVER HEATING" IT IS ADVISED TO PURCHASE A COMPUTER FAN (AVAILABLE AT RADIO SHACK) THIS CAN BE ATTACHED TO THE PRINTER TO SUCK OUT THE HOT AIR.

## DIFFERENT COLORED TEXT & BACKGROUND

TRY THESE POKES TO CREATE DIFFERENT COLOR TEXT ON DIFFERENT BACKGROUNDS. INSERT THEM IN YOUR PROGRAMS TO "SPICE THEM UP". YOU MUST BE IN BASIC FOR THESE TO WORK.

|                     |                      |
|---------------------|----------------------|
| POKE 17115,26:TEXT  | BLACK ON YELLOW      |
| POKE 17115,29:TEXT  | BLACK ON PURPLE      |
| POKE 17115,246:TEXT | WHITE ON DARK RED    |
| POKE 17115,21:TEXT  | BLACK ON DARK BLUE   |
| POKE 17115,19:TEXT  | BLACK ON LIGHT GREEN |
| POKE 17115,26:TEXT  | BLACK ON GREEN       |
| POKE 17115,254:TEXT | WHITE ON GREY        |
| POKE 17115,30:TEXT  | BLACK ON GREY        |
| POKE 17115,24:TEXT  | BLACK ON MEDIUM RED  |

## GET IT DONE FASTER WITH A DISK DRIVE

JUST A NOTE ABOUT THE ADAM DISK DRIVE. WE HIGHLY RECOMMEND IT BECAUSE IT REALLY DOES THE JOB FAST!!! FOR EXAMPLE, IF YOU HATE SITTING THERE WAITING A MINUTE AND A HALF TO LOAD IN SMARTBASIC, GET YOURSELF A DISK DRIVE, USE ONE OF THE COPY PROGRAMS NOW AVAILABLE FOR ADAM (SEE SOFTWARE SECTION) AND MAKE A BACK-UP COPY OF YOUR SMARTBASIC TAPE ON DISK. YOU WILL FIND YOUR DISK WILL LOAD BASIC IN 15 SECONDS FLAT!!!

## SOME BASIC INFORMATION

HERE'S A FEW "SMARTBASIC" FACTS:

? = PRINT (SAVES TIME IN WRITING PROGRAMS)

DATA PACKS STORE 32 FILES & NO MORE

DON'T STORE PROGRAMS (OTHER THAN HELLO PROGRAM) ON YOUR SMARTBASIC TAPE.

IF THE CURSOR IS PAST THE RETURN SYMBOL...USE THE DOWN CURSOR COMMAND TO UNLOCK THE KEYBOARD. YOU MAY THINK THE KEYBOARD IS LOCKED UP BUT ADAM IS DOING SOME ELECTRONIC HOUSE KEEPING (WAIT ONE MINUTE)

## DON'T SPLIT TEXT IN SMARTBASIC

IT'S EASY TO WRITE TEXT IN SMARTBASIC WITHOUT TAKING A LOT OF TIME TO MAKE SURE WORDS ARE NOT SPLIT-UP. THERE IS NOTHING MORE UNPROFESSIONAL THAN SPLIT-WORDS. DO THE FOLLOWING AND YOU'LL FIND IT TO WORK QUICKLY & EASILY ONCE YOU GET USED TO DOING IT. 1. START TYPING YOUR TEXT. 2. CONTINUE TYPING ON THE NEXT LINE. 3. WATCH TO SEE WHEN YOU ARE TYPING DIRECTLY UNDERNEATH THE QUOTATION MARK OF THE PREVIOUS LINE. 4. IF THE WORD YOU ARE TYPING DOES NOT END BEFORE REACHING THE POINT DIRECTLY UNDER THE QUOTATION MARK, YOU NEED TO SKIP ENOUGH SPACES TO START PRINTING YOUR NEXT WORD IMMEDIATELY FOLLOWING THE SPACE UNDER THE " MARK.

WHEN YOU RUN THIS PROGRAM YOU WILL FIND YOUR TEXT UN-SPLIT!

IF YOU WISH TO CENTER ALL YOUR TEXT, REFER TO THE CHART LATER IN THIS SECTION.

HERE'S A BRIEF EXAMPLE OF THIS METHOD. (IT WORKS BY THE WAY ON ANY COMPUTER):

```
20 PRINT "HELLO...I AM TRYING TO  
    DEMONSTRATE HOW TO TYP  
E TEXT IN SMARTBASIC AND END UP  
WITH A LOT OF SPLIT WORDS!"
```

## REALLY DELETING FILES

WHEN YOU DELETE FILES IN SMARTBASIC, IT ACTUALLY ONLY ERASES THE FILE NAME FROM THE TAPE OR DISK. TO ACTUALLY CLEAN-UP THE TAPE, RUN THE FOLLOWING PROGRAM.

```
10 D$=CHR$(4)  
20 ? D$;"OPEN<FILENAME>"  
30 ? D$;"WRITE<FILENAME>"  
40 ?  
50 ? D$;"CLOSE<FILENAME>"
```

AFTER THIS PROGRAM RUNS, TYPE IN "DELETE <FILENAME>" AND HIT RETURN.

**\*\*TPS\*\***  
**SMARTBASIC**  
**TEXT-CENTERING**  
**CHART**

Brought to you by THE OMAHA ADAM USERS CLUB  
and Norman R. Castro, Founder

| Use H TAB | Word/Text Length    | To Center Word/Text |
|-----------|---------------------|---------------------|
| 15        | 1                   |                     |
| 15        | 22                  |                     |
| 14        | 333                 |                     |
| 14        | 4444                |                     |
| 13        | 55555               |                     |
| 13        | 666666              |                     |
| 12        | 7777777             |                     |
| 12        | 88888888            |                     |
| 11        | 999999999           |                     |
| 11        | 10 - - -10          |                     |
| 10        | 11 - - - 11         |                     |
| 10        | 12 - - - -12        |                     |
| 9         | 13 - - - - 13       |                     |
| 9         | 14 - - - - - 14     |                     |
| 8         | 15 - - - - - 15     |                     |
| 8         | 16 - - - - - -16    |                     |
| 7         | 17 - - - - - - 17   |                     |
| 7         | 18 - - - - - - - 18 |                     |
| 6         | 19 - - - - - - - 19 |                     |
| 6         | 20 - - - - - - - 20 |                     |
| 5         | 21 - - - - - - - 21 |                     |
| 5         | 22 - - - - - - - 22 |                     |
| 4         | 23 - - - - - - - 23 |                     |
| 4         | 24 - - - - - - - 24 |                     |
| 3         | 25 - - - - - - - 25 |                     |
| 3         | 26 - - - - - - - 26 |                     |
| 2         | 27 - - - - - - - 27 |                     |
| 2         | 28 - - - - - - - 28 |                     |
| 1         | 29 - - - - - - - 29 |                     |
| 1         | 30 - - - - - - - 30 |                     |
| 1         | 31 - - - - - - - 31 |                     |

When using SmartBASIC and you have Instructions/Text on the TV screen it is distracting to see some words that are started on one line and continue on the next line. This pyramid will help you to choose the correct H Tab to center each Line/Paragraph. Do not exceed 30 Characters per line.

The maximum number of Text lines that can be on the TV screen while in SmartBASIC is 24. This includes any spaces between paragraphs. VTAB 1 is printed on the first line while VTAB 24 will print on the last line (24). Use the VTAB first followed by the HTAB #. Example: 10 VTAB 6: HTAB 2: PRINT "Modified by Norman R. Castro" This will be on the 6th line and indented one space.

# PRINTERS/RIBBONS & REUSE/REWINDING

Brought to you by THE OMAHA ADAM USERS CLUB  
and Norman R. Castro, Founder

## PRINTER RIBBONS & REUSE/REWINDING

This modified ADAM printer ribbon case will enable you to rewind other ribbons and place them back into their former ribbon cases for reuse. Or you could use this modified ribbon case immediately after rewinding by inserting the Ribbon advance knob, pivot arm & the rubber ring. NOTE if this is not done correctly the ribbon will NOT advance properly and your printed sheet will be extremely light in print.

You will need the following tools:

1. A small thin blade screwdriver
2. A clean putty knife
3. A flat 1/8" punch
4. An Xacto hammer with the steel head
5. A variable speed(preferred) electric drill
6. A 3/8" Brad point wood drill bit with cutting flutes
7. A hobby type small electric drill with a 1/4" circular blade
8. Fine sandpaper

A. Remove the small rubber ring & set aside. NOTE: Before removing any parts read over all of the instructions to acquaint yourself so that you will be able to replace each part correctly.

B. Use the small thin blade screwdriver to pry open the top of the ribbon case. Take your time as there are 6 plastic pins that are part of the top cover that have to be coaxed open(pried apart) from the bottom. Use the putty knife to help keep this case apart while working your way around the case. Set the top of the case aside.

C. Remove the 1" pivot arm by lifting it straight up along with the Ribbon Advance Knob & set both aside.

D. Remove the empty supply spool on the right by lifting straight up. Leave the end of the ribbon attached & set aside.

E. Take the clean putty knife & insert it carefully under the take-up spool of the used ribbon & core. Move this as one unit & set aside.

F. To remove the 2-1/2" thin round plastic disk that the used ribbon was on top of, turn over the ribbon case & tap it out & set aside.

G. Use the small hobby drill(Dremel Moto-Tool type) with the 1/4" blade & remove the 3/8" plastic stud that held the fresh supply of ribbon on the right side. Cut flush to the ribbon case & sand slightly to remove burs etc. Clean the bottom of the ribbon case & wipe with a clean rag. Set aside.

H. Take the ribbon case top and use the 1/8" flat punch on the INSIDE, where the fresh ribbon was & flatten the center dimple so that the Brad point wood drill bit won't slip.

I. Drill a 3/8" hole where that dimple was using the Brad point wood bit. You'll end up with a hole on the top of the ribbon case that will now enable you to insert a 3/8" dowel (around 8" long) into the right spool core to rewind the used ribbon on.

J. Replace the 2-1/2" thin round plastic disk on the left.

K. Replace the full used ribbon with the core intact back on the round plastic disk (use the clean putty knife). Take the empty core with the ribbon attached & put it back in the bottom right of the ribbon case.

L. Do NOT replace the Ribbon Advance Knob (Ratchet) OR the 1" pivot arm (Tongue). Thread the ribbon back on the empty core by-passing the tension wire and put the ribbon case cover back on & PRESS carefully at the 6 plastic pins (Pegs) to close this tightly. This is to insure that the ribbon will rewind evenly and not be lumpy.

M. Insert the 3/8" wood dowel in carefully as far as it goes and begin to rewind COUNTER Clock Wise until finished. Do not hurry your almost finished.

N. When the rewinding is finished carefully take out the rewound supply ribbon & empty core from the left & transfer this to the original ribbon case on the right side (supply spool). Don't forget to install the Ribbon Advance Knob (Ratchet) and the 1" pivot arm (Tongue) back in. Rethread the ribbon as shown & don't forget the tension wire.

NOTE: IF YOU FIND IT PRINTS DARK FOR A WHILE BUT SUDDENLY BECOMES TOO LIGHT IT IS BECAUSE THE RIBBON IS NOT MOVING IN THE PROPER GUIDE PATH: This is usually caused by...

A. Ribbon not positioned around the  $\pi$  side of the tension wire.

B. Ribbon not positioned properly around the ratchet on the left side.

Pop the top and compare how it looks to the sketch.

DRAWING COURTESY of  
NICKELODEON GRAPHICS

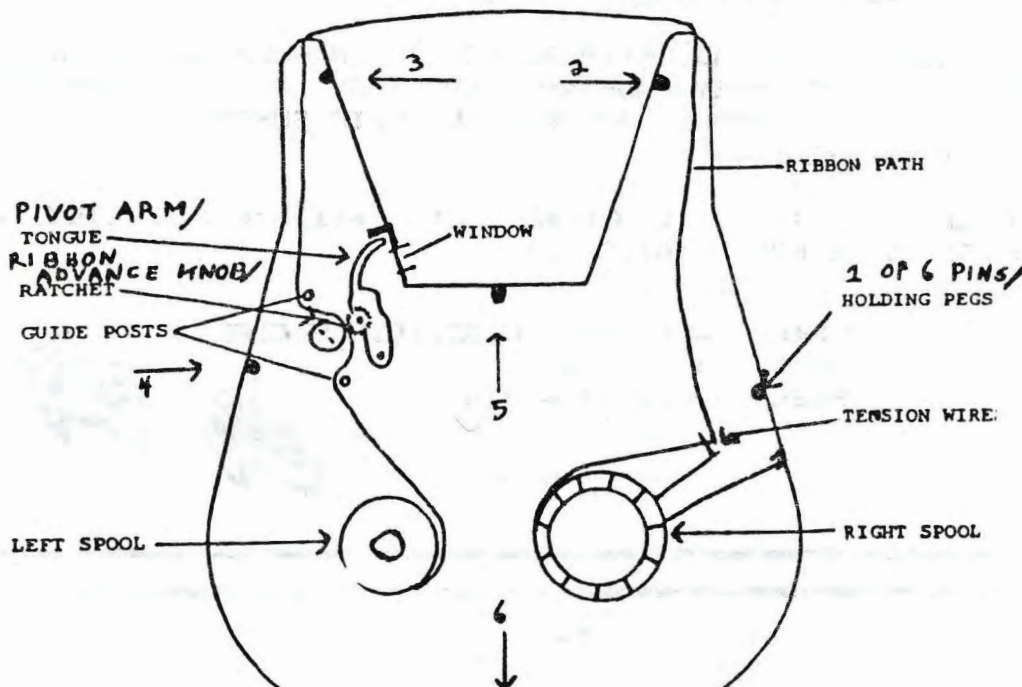

# the ADAM<sup>TM</sup> Resource

P.O. BOX 90  
SEELYVILLE, INDIANA 47878



## SECTION NINE (#9)

# AD-SECTION

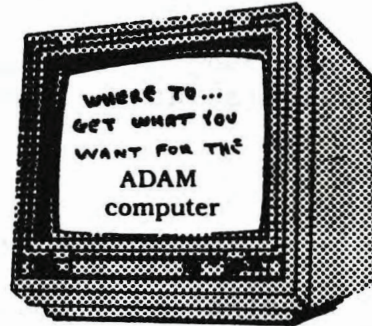

THIS SECTION WILL PROVE TO BE A MOST VALUABLE SECTION TO YOU. IN THE NEXT SEVERAL PAGES YOU WILL FIND ADS FROM THE LEADING ADAM SUPPLIERS. WE ENCOURAGE YOU TO SUPPORT THESE PEOPLE BECAUSE IT DEPENDS ON YOU WHETHER THEY CONTINUE TO BE ADAM SUPPLIERS AND WE WAN'T THEM TO BE AROUND FOR A LONG TIME!!

WE WANT TO THANK THESE ADVERTISERS FOR THEIR HELP IN MAKING THIS DIRECTORY POSSIBLE. THEY MADE AN INVESTMENT IN THIS PUBLICATION BEFORE IT EVER WAS, AND WE APPRECIATE THEIR SUPPORT. TO THEM WE SAY "A BIG THANK YOU"!!!

**IF YOU WOULD LIKE TO ADVERTISE...**  
SIMPLY WRITE TO US FOR DETAILS AT:

**THE ADAM RESOURCE**  
DEPT. 90 BOX 90  
SEELYVILLE, IN 47878

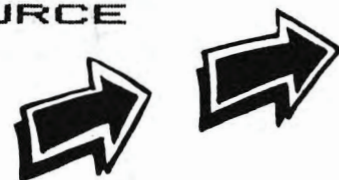



# COLECO ADAM \*\*\*OUTLET\*\*\*

## EVERYTHING FOR ADAM

|  |           |             |
|--|-----------|-------------|
| Data Pack(Pre/Formatted Adam)                  | Coleco's  | \$3.95      |
| Data Pack (Pre/Formatted)                      | w/o label | 10/\$37.50  |
| Disks (blank for Adam)                         |           | 10/\$19.95  |
| Disks (blank for Adam)                         |           | 30/\$49.50  |
| Ribbon Cart. (Adam printer)                    |           | \$5.50      |
| Ribbon Cart. (Adam printer)                    |           | 3/\$15.00   |
| Daisy Wheel - Elite, Script, Italic, etc.      | \$5.50    |             |
| Covers (3) Keyboard,CPU,Printer                |           | \$18.95     |
| Labels T/F-F/F (Address)                       |           | 1000/\$5.00 |
| Labels T/F-F/F (Data Pack)                     |           | 100/\$5.00  |
| PRINTER STAND - Front ON/OFF switch            |           | \$22.95     |
| TRACTOR FEED - For all fanfold paper & Labels  |           | \$79.95     |
| * Combo SPECIAL - TRACTOR FEED & PRINTER STAND |           | \$98.95     |

### FREE CATALOG - Everything for ADAM

|  |         |
|--|---------|
| <u>PACKCOPY</u> - Make backup copies of SmartBASIC etc.  | \$29.95 |
| <u>POWERPRINT</u> - Right/justification-Auto/center,etc.   | \$24.95 |
| <u>EBU</u> - SmartBasic - Data or Disk. sound,renumber   | \$21.95 |
| <u>THE STOCK MARKET GAME</u> - A fun & educational game  | \$24.95 |
| <u>BLACK GOLD</u> - Look for oil. Survey-profits-fun   | \$24.95 |
| <u>DIABLO</u> - Great mind challenge-All Graphic   | \$24.95 |
| <u>MORSE CODE</u> - Learn & Practice   | \$19.95 |
| <u>BOUNTY HUNTER</u> -Text adventure   | \$24.95 |
| <u>A HACKER'S GUIDE TO ADAM</u> - Included DP & book. Internal workings hardware & Software programs. Cartridge copy. Sprite Editor, Font Editor & much more.          |         |
|  | \$17.95 |
| <u>SmartSPELLER</u> - Electronic dictionary locates & checks misspelled words, & much more.specify DP or disk  | \$39.95 |
| <u>FastFILER</u> - Generate maillists, etc. sorts & look-up in seconds. This is a complete Data Base System. Printing either mailing lists or customized report format | \$24.95 |
| <u>ADAM ENTERTAINER</u> - Book (sound,graphics,programs)   | \$12.95 |
| <u>ADAM'S COMPANION</u> - Book(updated)  | \$9.95  |
| <u>LEARNING TOGETHER WITH ADAM</u> - Book includes LOGO  | \$9.95  |
| <u>CHARTS &amp; GRAPH ASSEMBLER</u> -Auto-proportions input,Create pie charts, bar graphics, and line graphs, etc.   | \$24.95 |
| <u>BUSINESS</u> - A complete set of 5 business programs  | \$89.00 |

S&H-\$2.50 US

S&H-\$4.50 CN

VISA/MASTER

M.W. RUTH CO. Dept.A85  
510 Rhode Island Ave.  
Cherry Hill, NJ 08002  
(609) 667-2526

We stock what we sell, for fast delivery.

Join the leading ADAM users' group

#### #1 ADAM USERS' GROUP

Receive "SPRITE CHASER" newsletter.  
Advanced updating, evaluations on  
programs & hardware, technical in-  
formation direct from Coleco.  
Problem solving - program exchange-  
discount buying service - etc.  
Send \$15 for Charter membership to:

#1 ADAM USERS' GROUP  
P.O. Box 3761 - Atten: Jay Forman  
Cherry Hill, NJ 08034

(609) 667-2526 \* VISA/MASTER-ADD \$1

ADAM  
USERS!

ADAM  
USERS!

# smartBASIC BONANZA!

## 15 programs for ADAM on one cassette

### OUTSTANDING REVIEWS

"smartBASIC BONANZA is the best... You will never spend \$34.95 more wisely."

— Expandable Computer News

"fun... useful... amazingly low cost"

"... worth every cent."

— ADAM Users Club

"... fine programs... well written and appealing."

— AUGment (ADAM Users)

— Computer Entertainer

**DESIGN:** hi res figures

**SOUNDER:** music and sound

**OTHELLO:** the board game

**MANSION:** adventure game

**FINANCE:** budget, metric,

interest projections

**FUGUE:** 3 instrument music

**MAGIC:** amaze your friends

**TYPYER:** tutor, video game

**TRYME:** 2 educational games

**MINIASSEMBLER:** write machine code

**DISASSEMBLER:** decipher machine code

**FILER:** database

**LABELS:** make labels from FILER files

**TENNIS:** pong game

**BREAKOUT:** video game

+SURPRISES

# FANTASY GAMER



## 3 BIG PROGRAMS FOR THE ADAM\*

**THE VISITOR:** Interactive fiction with animated graphics. Your smart but odd companion must rendezvous with its mother ship.

**BOMB SQUAD:** Graphic adventure. Find the terrorists' bombs in time.

**ADVENTURE CREATOR:** Write your own adventure games. Instructions, "framework" program, graphics subroutines, fast machine language parsing routine.

READ THE REVIEW FROM COMPUTER ENTERTAINER

JUNE 1985 (12115 Magnolia Blvd., No. Hollywood, CA 91607)

ADAM FANTASY GAMER (★★1/2/★★★★1/2) from *Martin Consulting* of Canada includes three programs: two text adventures with graphics and an "Adventure Creator," which is the real star of the show. The programs are written in SmartBASIC, but the parser (the portion of the program that analyzes the player's keyboard input) is in machine language. This allows faster analysis of commands and use of more words in the game vocabulary than adventure games written entirely in BASIC.

#### The Adventures

Ideally, you should play and solve both games before moving on to the Adventure Creator, since working with the Creator reveals many "secrets" of the two adventures. The first game is "Bomb Squad," an intermediate-level adventure in which you must find and deactivate three bombs planted by terrorists in the embassy of Lunaria. The second is a fantasy adventure, "The Visitor," in which you befriend an alien being and help him find his mother ship. Both

adventures include illustrations with some animation. These are not mere decoration, since important clues are revealed graphically. Both games are well written and compare favorably with the few other adventures available for Adam.

#### Adventure Creator

The best reason for owning this program is the Adventure Creator, which is well supported with a detailed instruction manual. Creating an adventure from scratch is an involved and difficult task that is made easier with Adventure Creator. The program assumes that you understand BASIC programming, and you will have to put that knowledge to work. The manual guides you through the process of mapping your game, provides a listing of the Creator program, explains the operation and application of the parser, and teaches you the use of sprites to create animated graphics. (For some Adam owners, the section on sprites alone makes the program a worthwhile purchase.) When you have completed your first adventure with the help of the Creator, you will have learned more about programming than you knew before you started. You'll have fun, of course, but the knowledge gained is a lasting benefit of the program. (Solo use; Keyboard; Digital data pack.)

Recommended. (MSB \$34.95)

EACH CASSETTE ONLY  
\$34.95 (US), \$43.95 (CDN)  
Money Order, VISA  
MasterCard (include  
expiry date)

Martin Consulting  
94 Macalester Bay  
Winnipeg, Manitoba  
R3T 2X5 Canada  
(204) 269-3234

ADAM and smartBASIC T.M. Coleco, Inc.

\*\*\*\*\*  
ADAM ADAM ADAM ADAM ADAM ADAM ADAM ADAM ADAM ADAM ADAM ADAM ADAM ADAM ADAM ADAM ADAM  
\*\*\*\*\*

SAGE ENTERPRISES was one of the first companies to provide support for Coleco's ADAM Family Computer System. We plan to continue providing support through software development and the continued publication of Expandable Computer News. If you are an ADAM owner looking for products and support then we can help you. While other groups and publications make promises, take your money and make you wait for service; we are busy producing software and a high quality publication that is now entering its second year of support to ADAM owners. A number of our current products are listed below. All of these items are currently available.

\*\*\*\*\*  
EXPANDABLE COMPUTER NEWS  
\*\*\*\*\*

EXPANDABLE COMPUTER NEWS (ECN) was the first ADAM only publication. We carry all of the news about ADAM products, provide in-depth reviews, ready-to-run programs, articles, information on ADAM's operating system, columns on telecommunications, developments in the home computer market, an up-to-date list of users groups, problems and solutions. In our second year we will be adding columns on LOGO, CP/M, and expanded information on programming in BASIC and assembly language. ECN is published bi-monthly. If you would like to know more about ECN, write us and we will send you a sample so that you can look us over. We think you will agree that ECN is a must and is well worth the price (\$12.00 U.S.).

\*\*\*\*\*  
PACKCOPY by UNREAL SOFTWARE COMPANY  
\*\*\*\*\*

If you are looking for a backup system that will allow you to copy ADAM software then you need PACKCOPY. Not only does PACKCOPY produce backups on data pack, it will also produce copies on disk of most ADAM software that can be loaded and run directly from disk. PACKCOPY lets you make backup copies with one data drive or multiple data drives or disk drives. PACKCOPY will copy all current non-SUPER GAME software. Some Super-Games cannot be copied with the current version of PACKCOPY. In addition Super-Games were written specifically to run from Data Drive #1 and cannot currently be made to run from disk. We are looking for solutions that will allow backing up all Super Games and registered owners of PACKCOPY will be supplied with updates as new versions become available. PACKCOPY is currently available only on data pack and may be ordered from Sage Enterprises for \$41.50 U.S.(foreign prices will vary).

\*\*\*\*\*  
ECN PROGRAM LIBRARY SOFTWARE  
\*\*\*\*\*

In conjunction with EXPANDABLE COMPUTER NEWS we are also making available a variety of BASIC programs on data pack. Each Program Library data pack contains a variety of programs. These are being offered at the current low price of \$9.95 U.S. for each data pack.

Program Library 1 includes the following programs: checkbook balancer, mailing list, graphics and sound demos, picture drawing, grades, and envelope addresser.

Program Library 2 includes: a screen and text color changer, music player, sprite demo, filing system, games, statistics, grade point average, timer, and graphics demos.

\*\*\*\*\*

All of the above items may be ordered by sending a check or money order (no charge cards or C.O.D.s) payable in U.S. funds to Sage Enterprises, Route 2, Box 211, Scrivner Road, Russellville, MO 65074.

Coleco, ADAM, Super Games are all trademarks of Coleco Industries. PACKCOPY is copyrighted by Sage Enterprises. Sage Enterprises is in no way affiliated with Coleco Industries.

# ALPHA-1

DISCOUNT HOME COMPUTER SUPPLIER

1671 EAST 16th ST., SUITE 146 • BROOKLYN, N. Y. 11229

COMPUTER PERIPHERALS FOR THE ADAM

ADAM 5 1/2 Disk Drive.....\$189  
 ADAMLINK Direct Connect Modem.....\$ 94  
 ADAM 64K Memory Expander.....\$ 99  
 Extra Digital Data Drive.....\$ 97  
 Address Book Filer & Autodialer.....\$ 29  
 Adjustable Tractor Feed Assembly....\$ 80  
 (Available approximately July 15)

COMPUTER SUPPLIES FOR THE ADAM

Daisy Wheels-Pica 10,Courier 10,Emphasis,  
 Courier 72 EACH \$5.00  
 Printer Ribbon For ADAM.....\$5.00  
 Loran Digital Data Pack.....\$5.00  
 Dust Cover For ADAM.....\$18.50  
 (Vinyl brown 3 piece-CPU,KYBD,PRT)  
 ADAM Accessory Kit.....\$29.00  
 Maxell 5 1/2 SS/DD Disks (10).....\$18.00  
 Memorex 5 1/2 SS/DD Disks(10) w/case.\$19.00  
 Nashua 5 1/2 SS/DD Disks Loose.....\$1.25EA  
 (Must order 15 or more for pricing)  
 ADAM Monitor Cable.....\$8.50  
 Compuserve Starter Kit.....\$21.00  
 Disk Storage holds 50 5 1/2 disks...\$11.00  
 Disk Storage holds 10 5 1/2 disks....\$ 4.50

VICTORY SOFTWARE FOR THE ADAM

Adventure Pack I (DP,Disk).....\$21  
 Adventure Pack II (DP,Disk).....\$21  
 Bounty Hunter (DP,Disk).....\$21  
 Savings & Loan (DP,Disk).....\$18  
 TREK (DP,Disk)space adventure.....\$21  
 Strategy Pack I.(DP,Disk).....\$15  
 Games Pack I (DP,Disk).....\$15  
 Compatible Pre-Formatted Blank Data  
 Packs by VICTORY  
 SPECIAL SALE PRICE \$2.75 Each

COLECOVISION CARTRIDGES FOR ADAM

War Games,Tarzan,Star Trek,Brain Strainers,  
 Smurf Paint-N-Play,Telly Turtle,Dr.Seuss  
 Fix-Up Puzzler,Monkey Academy,Choplifter,  
 Fortune Builder,Root Beer Tapper,Spy Hunter,  
 2010,Cabbage Patch Kids Picture Show,  
 Illusions,Dam Busters(flight simulator)  
 SPECIAL PRICE \$19.00 Each  
 Antarctic Adventure,Burger Time,Sub Roc,  
 Roc-N-Rope,Rocky,Gorf  
 SPECIAL PRICE \$15.00 Each

SUNRISE SOFTWARE FOR ADAM

Gust Buster (DP,Disk)arcade action...\$15  
 Rolloverture (DP,Disk)music education\$15  
 Quest For Quintana Roo (DP,Disk).....\$15  
 Mountain King (DP,Disk)sensory strat.\$15

32 Basic Programs for the ADAM

Book/Data Pack Package.....\$36  
 by Dilithium Press

\*\*\*\*\*  
 FOR MORE INFORMATION OR TO BE INCLUDED ON OUR MAILING LIST SEND A SELF-ADDRESSED STAMPED BUSINESS  
 SIZE ENVELOPE TO THE ABOVE ADDRESS.--THANK YOU--

ORDERING & TERMS: Send cashier's check,money order,personal or company check.All orders shipped  
 within the continental USA add \$1.50 per order shipping charges. All others add  
 5% of total order(minimum \$3.50) for shipping charges.NY state residents must  
 add sales tax. C.O.D. orders phone 718-336-7612. Orders shipped in 48 hours if  
 in stock. Canadian orders must be a Postal Money Order in US currency.

COLECO SOFTWARE FOR THE ADAM

CP/M 2.2 & Assembler(DP,Disk).....\$47  
 ADAMCALC(DP)spreadsheet program....\$39  
 SMART LOGO(DP).....\$47  
 SMART FILER(DP,DISK).....\$19  
 EXPERTYPE(DP,Disk).....\$35  
 SMART LETTERS & FORMS(DP,Disk)....\$25  
 DONKEY KONG(DP).....\$18  
 DONKEY KONG JR(DP).....\$18  
 SUPER ZAXXON(DP).....\$18  
 DRAGON'S LAIR(DP,Disk).....\$19  
 ELECTRONIC FLASHCARD MAKER(DP)....\$18  
 \*FLASH FACTS-TRIVIA(DP).....\$10  
 \*FLASH FACTS-VOCABULATOR(DP)....\$10  
 \*FLASH FACTS-AMERICAN HISTORY(DP)..\$10  
 ELECTRONIC WORD BOOK(DP).....\$18  
 RECIPE FILER(DP,Disk).....\$19  
 WACKY WORD GAMES(DP).....\$17  
 (Word Processing Game)  
 BEST OF BRODERBUND(DP).....\$19  
 (Choplifter & AE)  
 FAMILY FEUD(DP).....\$19  
 JEOPARDY(DP).....\$19  
 BEST OF ELECTRONIC ARTS(DP).....\$19  
 (Hard Hat Mack,Pinball Construction)  
 2010 (DP,Disk).....\$19  
 (space text adventure)

\*NOTE:FLASH FACTS REQUIRES ELECTRONIC  
 FLASHCARD MAKER.

PARALLEL SYSTEMS SOFTWARE FOR ADAM

Home Budget Planning (DP)  
 Personal Checkbook Manager (DP)  
 Home Files Manager (DP)  
 States & Capitals (DP)  
 World Capitals (DP)  
 Great Inventions Game (DP)  
 Party Trivia (DP)

SPECIAL SALE PRICE..\$10 EACH

SUPER SKETCH by PERSONAL PERIPHERALS

Includes a Controller Pad and a Sketch  
 Master software cartridge compatible  
 with ADAM.....\$29

PERSONAL ACCOUNTANT by SOFTSYNC INC.

Compiles financial reports,large data  
 base,breaks down expenses,amortization,  
 payment schedules.  
 On Digital Data Pack.....\$24

MARTIN CONSULTING SOFTWARE

SMARTBASIC BONANZA:15 programs,including  
 Othello,Design,Filer,Disassembler,Labels,  
 Mini-assembler,Magic,Finance,Tennis etc.  
 On Data Pack.....\$29  
 FANTASY GAMER:3 big programs,2 adventures  
 with graphics plus Adventure Creator.  
 On Data Pack.....\$29

# \*\*\*\*\* UNCLE ERNIE'S TOOLKIT \*\*\*\*\*

## for the ADAM™ computer!

UNCLE ERNIE'S TOOLKIT IS A UTILITY PROGRAM FOR ADAM THAT ALLOWS YOU TO PERFORM VARIOUS DATAPACK AND DISK OPERATIONS NOT PREVIOUSLY POSSIBLE. IT IS MENU-DRIVEN, USING THE SMART KEYS TO CONTROL THE VARIOUS FUNCTIONS.

THE PROGRAM CONSISTS OF A MAIN MENU LEADING TO FOUR PRIMARY FUNCTION MENUS: BACKUP, SCAN/DUMP, MODIFY, AND CATALOG. SUB-MENUS SHOW THE OPTIONS FOR EACH FUNCTION.



AT THE BOTTOM OF THE SCREEN, THE STATUS FIELD SHOWS THE CURRENT SOURCE AND TARGET DRIVE, AND THE CURRENT SETTINGS OF USER-DEFINED PARAMETERS. DEFAULTS ARE SET AT START-UP TO THE STANDARD CONFIGURATION FOR EACH FUNCTION.

BACKUP WILL MAKE BACKUP COPIES OF ADAM DATAPACK AND DISK SOFTWARE (INCLUDING SMARTBASIC AND SMARTLOGO), USING EITHER ONE OR TWO DRIVES, DISK OR TAPE. ANY OR ALL BLOCKS MAY BE COPIED.

SCAN/DUMP MAY BE USED TO FIND "LOST" FILES, OR SIMPLY TO EXPLORE THE CONTENTS OF YOUR DISKS OR DATAPACKS. BLOCKS MAY BE DUMPED TO PRINTER IN HEX/ASCII, DECIMAL/ASCII, OCTAL/ASCII, OR ASCII ONLY FORMAT.

MODIFY IS A "PATCH" UTILITY. IT MAY BE USED, FOR EXAMPLE, TO SET THE DEFAULT DRIVE IN SMARTBASIC TO RUN THE HELLO PROGRAM FROM DISK WHEN YOU BOOT FROM DISK. YOU MAY ALSO USE MODIFY TO RESTORE "DELETED" FILES THAT HAVE NOT YET BEEN WRITTEN OVER.

CATALOG IS AN EXPANDED DIRECTORY ROUTINE. USE IT TO LIST THE FILES ON YOUR DISK OR DATAPACK, INCLUDING SYSTEM FILES AND ANY "DELETED" FILES THAT HAVE NOT YET BEEN WRITTEN OVER. IT ALSO LISTS THE STARTING BLOCK NUMBER AND SIZE FOR EACH FILE.

A 30-PAGE USER'S MANUAL EXPLAINS THE VARIOUS PROCEDURES.

## ONLY \$23 disk • \$25 datapack

TO ORDER: SEND CHECK OR MONEY ORDER TO UNCLE ERNIE'S SOFTWARE, 279 EASTHOLM AVE., AKRON, OH 44312. PLEASE INCLUDE \$2 POSTAGE/HANDLING.

IMPORTANT NOTICE: COPYRIGHT LAW ALLOWS YOU TO MAKE ARCHIVAL BACKUPS ONLY FOR YOUR PERSONAL USE. IT IS ILLEGAL TO DISTRIBUTE COPIES OF COPYRIGHTED SOFTWARE TO OTHERS.

(ADAM, SMARTBASIC, AND SMARTLOGO ARE TRADEMARKS OF COLECO INDUSTRIES)

# THE FAMILY PAK



15 quality programs for **ADAM™**  
on one data pack!

ONLY \$ **19**<sup>95</sup>

POST  
PAID!

DISC  
ALSO  
AVAILABLE!

A VARIETY OF PROGRAMS FOR THE ENTIRE FAMILY...

\*BINGO \*SLOT MACHINES \*CHR\$ LIST \*WORD SEARCH PUZZLE MAKER  
\*HORSERACE \*GROCERY LIST MAKER \*LANDING MISSION \*ADAM-QUIZ  
\*MUSICAL CHRISTMAS TREE \*MUSICAL BIRTHDAY \*ROCKET LAUNCH

\*COLOR FUN \*EXERCISE ROBOT \*CRAPS  
\*COMMAND CHANGER (SECURITY UTILITY)

ALL PROGRAMS  
WRITTEN IN BASIC AND  
LISTABLE

SEND CHECK OR MONEY ORDER... **Programs  
Guaranteed!**

FOR MORE INFO AND OTHER  
ORIGINAL TIPS SEND SASE TO:

SPECIFY DISC OR DATA-PACK

## ADAM-HACK PRODUCTIONS

P.O. BOX 184 SEELYVILLE, IN. 47878

ADAM IS A TRADEMARK OF COLECO INDUSTRIES

# ADAM SOFTWARE

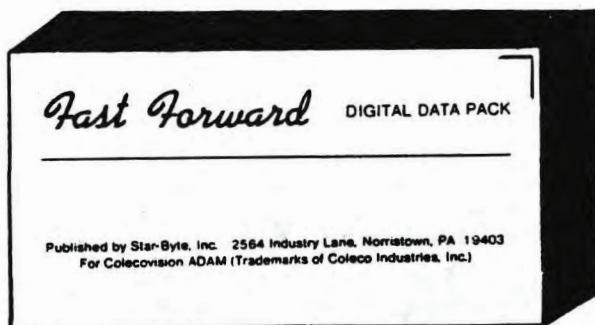

**DIGITAL DATA PACKS for the  
COLECOVISION ADAM  
In Stock 6-pack for \$21.95**



\$24.95

## TREK

The classic game that has fascinated computerists for over a decade. Commanding the bridge of your starship, you explore the galaxy, fending off the Klingon invaders with your phasers and photon torpedoes, at the same time conserving your limited time and energy.



\$24.95

## ADVENTURE PACK I (3 programs)

**MOON BASE ALPHA.** Destroy the meteor that is racing towards the moon or else your colony will be destroyed.  
**JACK & THE BEANSTALK.** Defeat the giant in your quest for his golden hen.  
**COMPUTER ADVENTURE.** Re-live the "excitement" of getting your first computer. An adventure with a very different flair.



\$24.95

## ADVENTURE PACK II (3 programs)

**AFRICAN ADVENTURE.** As the sole survivor of a plane crash, you must find your way out of the dark continent.  
**HOSPITAL ADVENTURE.** You are a spy whose mission is to complete the bungled assassination attempt on the evil dictator, who is recuperating in the hospital under heavy guard.  
**BOMB THREAT.** Get back to town to warn the authorities of the bomb planted by the terrorists who left you prisoner at their hideout.



\$24.95

## BOUNTY HUNTER

An adventure in the Old West. Journey back with us into the days of Jessie James and Billy the Kid, where the only form of justice was a loaded revolver and a hangman's noose. In this full length text adventure, you play the role of Bounty Hunter, battling against ruthless outlaws, hostile Indians, wild animals and the elements of the wilderness with only your wits and your six gun. Average solving time 20-30 hours. If you love adventures this one is a real treat.



\$24.95

## SAVINGS & LOAN

This extremely easy to use home finance program will quickly help you pick the best type loan for your budget. See what a small difference a couple of percent makes on a 4-year loan, and what a devastating effect a couple of percent makes on a 20-year mortgage. You can print out an amortization table of any loan. Need to save up for a down payment on a house, child's education, a trip? You can figure out the value of your investment based on one initial deposit, or deposits made yearly, semi-annually, monthly or weekly.

## PLUS Our Newest Titles

\$19.95 each



## STRATEGY PACK I (3 programs)

**PAYOFF.** One to four can play. Choose territories carefully; do you move for points now, or gamble for more points later?  
**HI-IQ.** Old European solitaire played on a cross shaped peg board. How many pegs can you remove?  
**JUMP.** Similar to HI-IQ except peg board is square. A different challenge.  
**OTHELLO.** Flank your opponents pieces and flip his discs.



## GAMES PACK I (3 programs)

**GOTCHA!** Sneak your way around a battlefield of mines and kamikase computer-controlled robot guards thirsting for your blood! Lure the guards into self-annihilation by hiding behind the mines.  
**STREET SWEEPERS.** Gobble up all of the dots in the maze before the Nemesis gets you. The maze is different everytime, and harder to complete as your skills increase.  
**CANNON.** Artillery battle. Lob shots at your opponent from your bunker over rugged and always different mountainous terrain.

## Committed to support ADAM

 **Star-Byte, Inc.**  
A Division of Robinson-Halpern Company

2564 Industry Lane · Norristown, PA 19403

**800/243-1515**

-61-

All prices tape or disk.  
All prices F.O.B. Norristown, PA  
Add \$1.50 per item to cover shipping charges.  
VISA/MC accepted.

ADAM is a registered trademark of  
Coleco Industries, Inc.



PRESENTS

**BACKUP+**

*CopyCart+*

Both programs are all machine language and self-booting. Both programs work with any equipped tape or disk drive and are menu driven and self prompting. The programs also come with a 90 day warranty and extensive operation manual.

BACKUP+

COPYCART+

- \* Features a 40K copy buffer to minimize media swaps and speed-up copying
- \* Automatically modifies BASIC as it is copied to disk to make it fully disk compatible
- \* Contains CATALOG and disk/tape INIT feature
- \* Supports multiple file copies with WILDCARD syntax which allows copying of several files without typing out each filename
- \* Allows multiple file copies on a single drive without swapping source and destination after each file copied
- \* Will copy programs like FILER, LOGO, CALC, etc., from tape to disk and readjust the directory "BLOCKS LEFT"

- \* Converts standard DDPs or disks to special self-booting TARGET media
- \* Copies cartridge programs to the TARGET media
- \* TARGET media can hold multiple cartridge programs
- \* TARGET media will self-boot and display a directory of all copied cartridges
- \* Program selection and execution is by number making the program easy to use even by young children
- \* Fully compatible with BACKUP+, COPYCART+ and TARGET media can easily be copied with the BACKUP+ "IMAGE COPY" feature

TAPE \$40 DISK \$37

TAPE OR DISK \$15

ALL PRICES INCLUDE POSTAGE

ORDER FROM:

MMSG

P.O. Box 1112

Broomfield, CO 80020-8112



# ADAM™ OWNERS

Finally, a computer desk designed expressly for the ADAM™ computer system. Features include, printer stand with front on/off, locking compartment with pullout keyboard shelf and data pack storage drawer, monitor shelf with space for CPU and disk drive. Constructed of lt. oak low pressure laminate.

PRICE: \$249.95

Introductory price of \$189.95 + S/H shipped unassembled. Please allow 4 to 6 weeks delivery.

COMING SOON!

A TRACTOR FEED FOR ADAM™

Suggested list \$59.95

For information call or write American Woodworks, 8 Failing Ave., St. Johnsville, New York 13452 (518) 568 7931

TOLL FREE - ORDERS ONLY 800 245 1090

Visa & Master Card Accepted.

---

---

## A.W.A.U.G.

WE serve Virginia, Maryland, and Wash., D.C.

Members of A.W.A.U.G. will have access to the following

- 1> ADAM'S RIB NEWSLETTER
  - 2> Technical information on hardware and software
  - 3> Access to the group's library
  - 4> programming help by programmers and hardware help by 5>
- LOW COST SUPPLIES FOR YOUR ADAM COMPUTER

USER GROUPS! Lets exchange information. Put us on your mailing list and will put you on ours.

J. Murphy, 2334 N. Oak St.  
Falls Church, VA 22046 ATT: Mike King

FOR SUPPLIES: DATALIFE DISKS \$21/24, BONUS DISKS \$11.5/12.5, LORAN DDP Tapes \$4/5, RIBBONS \$4/4.5, DAISY WHEELS \$4.5/5.5 the first price is for A.W.A.U.G. members and \*USER GROUPS. The 2nd price is our Regular low price. \* MIN ORDER tapes 100, disks 10 boxes, and RIBBONS 24.

Write for catalog or orders to: KING CO., 6702 James LEE ST. FALLS CHURCH, VA 22042. [call info for phone number]

# An Invitation To Join . . .



The ADAM computer has been exciting students, parents, hobbyists and all members of the family for only a short time, but the response to AUG (Adam Users' Group) has been much more than gratifying.

Now that Coleco has stopped production of this fine computer, it is more important that ADAM users communicate with other ADAM users. With this in mind, we offer you the following:

- HELPFUL HINTS ON USING SMARTWRITER, SMARTBASIC AND OTHER SOFTWARE DEVELOPED FOR THE ADAM COMPUTER
- PROGRAM AND HARDWARE AVAILABILITY.
- THIRD PARTY HARDWARE AND SOFTWARE VENDOR INFORMATION.
- EDUCATIONAL SOFTWARE AND GAME REVIEWS.
- PROGRAMS DEVELOPED BY MEMBERS.
- LIBRARY OF PUBLIC DOMAIN PROGRAMS ON BOTH DATA PACK & DISK.
- INFORMATION ON HOW TO START YOUR OWN LOCAL AUG.

The above is represented in our bi-monthly newsletter, **AUGment**, which is received by all members. Learn more about how you can get additional benefits from the **POWER** of ADAM and find out about what other **AUGies** are developing for the ADAM. **JOIN THE MORE THAN 5000 MEMBERS NOW !!!**

Just send in your check in the amount of \$12.00, payable to AUG, along with your name, address and telephone number to AUG, P.O. Box P-2, Lynbrook, N.Y. 11563.

**MENTION THIS AD AND RECEIVE A FREE ADAM PIN WITH YOUR MEMBERSHIP.**

# AUG

**ADAM USERS GROUP**

**P.O. BOX P-2**

**LYNBROOK, NY 11563**

# Las Vegas Adam Club

PRESENTS  
**Archives #1**

Featuring  
10 Great  
Programs  
**\$ 20.00**

ONLY

Available On  
Tape or Disk  
(Please Specify)

Send Check, M.O. or I.M.O.

TO:  
L.V.A.C.

P.O. Box 81146

Las Vegas, NV 89103

(personal checks require  
3 weeks to clear)

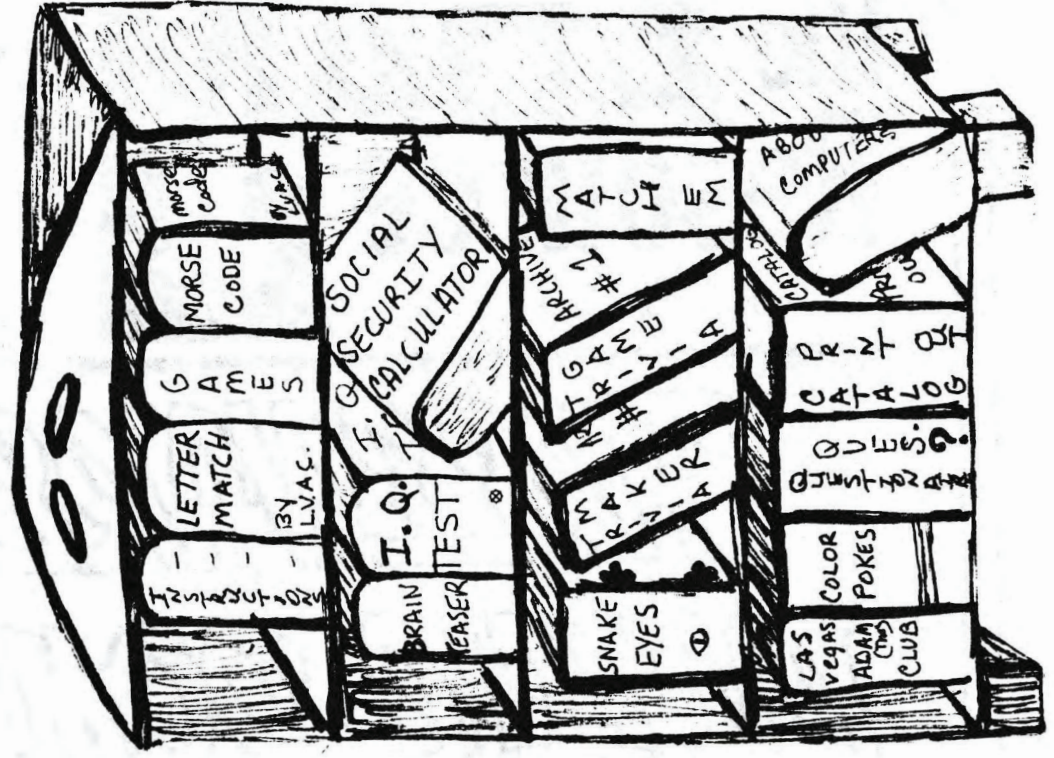

Start Your Library Now!

# the ADAM™ SECTION Resource TEN (#10)

P.O. BOX 90  
SEELYVILLE, INDIANA 47878



## FREWARE & PUBLIC DOMAIN

WHAT IS PUBLIC DOMAIN...  
OR FREWARE AS IT IS  
SOMETIMES CALLED ??????????

THIS TYPE OF SOFTWARE CAN BE COPIED AND SHARED WITH OTHERS AND AT THE SAME TIME YOU ARE NOT BREAKING OR VIOLATING ANY COPYRIGHT LAWS. IT IS AVAILABLE IN A NUMBER OF DIFFERENT WAYS, SOME OF WHICH ARE LISTED BELOW. THIS TYPE OF SOFTWARE IS NOT ALWAYS TOTALLY FREE AS YOU MIGHT BELIEVE...BUT RATHER MANY TIMES GROUPS, ONLINE SERVICES ETC... OFFER COPIES OF THEIR LIBRARIES OF PUBLIC DOMAIN SOFTWARE FOR A SMALL COST, BASICALLY TO COVER DISKS, HANDLING, ETC...

PUBLIC DOMAIN SOFTWARE IS PRESENTLY LIMITED FOR THE ADAM, HOWEVER, THE LIST OF SOURCES IS GROWING. WE HAVE INCLUDED SEVERAL SOURCES WITH DETAILS IN THIS SECTION...BUT WE ALSO SUGGEST YOU CHECK-OUT THE FOLLOWING RESOURCES FOR THIS TYPE OF SOFTWARE:



### USE YOUR MODEM

BBS'S, ONLINE SERVICES, AND OTHERS OFFER PDS PROGRAMS FOR

1. ADAM. (CHECK THE ON-LINE SECTION) THIS IS PROBABLY ONE OF THE BEST SOURCES FOR PDS.



### USER GROUPS

MANY USER GROUPS HAVE TOLD US THEY ARE IN THE PROCESS OF

2. PUTTING PDS PACKAGES TOGETHER. (SEE OUR USER GROUP LISTING)



### BOOKS

THERE ARE A NUMBER OF BOOKS DEVOTED ENTIRELY TO PDS SOFTWARE. YOU CAN OFTEN FIND THEM AT YOUR LOCAL LIBRARY.

3. (CHECK-OUT THE BOOKS & PUBLICATIONS SECTION) CONTINUED...

# \*\*PUBLIC DOMAIN\*



## ALTER PROGRAMS

DON'T GET DISCOURAGED IF ALL YOU SEEM TO FIND ARE PROGRAMS FOR OTHER COMPUTERS. THE FACT IS...MOST PROGRAMS CAN BE ADAPTED TO RUN ON THE ADAM.

IF YOU BECOME AWARE OF ADDITIONAL RESOURCES FOR PUBLIC DOMAIN SOFTWARE, OR IF YOUR USER GROUP PUTS TOGETHER A PDS PACKAGE, PLEASE SEND THAT INFO TO US AND WE'LL INCLUDE IT IN THE NEXT EDITION. SEND IT TO:

**THE ADAM RESOURCE**  
P.O. BOX 90 , DEPT. 100  
SEELYVILLE, IN 47878

---

## ADAM PUBLIC DOMAIN RESOURCES

### EXPANDABLE PROGRAM LIBRARY SOFTWARE

**SAGE ENTERPRISES**  
ROUT 2 BOX 211 SCRIVNER RD.  
RUSSELLVILLE, MO 65074

IN CONJUNCTION WITH EXPANDABLE COMPUTER NEWS, THEY OFFER A VARIETY OF PROGRAMS ON DATA-PACK. EACH PROGRAM PACK CONTAINS A VARIETY OF PROGRAMS. THEY ARE OFFERED AT A CURRENT PRICE OF \$9.95 EACH.

FOR A COMPLETE DETAILED LISTING OF THESE PROGRAM PAKS, PLEASE SEE THE EXPANDABLE COMPUTER NEWS AD IN OUR AD-SECTION.

**PUGET SOUND ADAM NETWORK**  
22607 SE 322nd  
KENT, WA 98042  
PHONE 206/886-1167  
(CIS # 70027,1703

PRESENTLY THEY OFFER SIX PACKAGES FOR ADAM AT A REASONABLE COST. YOU CAN EITHER PAY \$1/PROGRAM OR GIVE A PROGRAM IN EXCHANGE. THERE IS A \$5.00 CHARGE FOR A DISK ASSORTMENT. (\$1 CREDIT IS GIVEN FOR EACH PROGRAM GIVEN) YOU CAN ALSO SUPPLY YOUR OWN DDP OR DISK. SOME OF THE PACKAGES ARE LISTED ASFOLLOWS:

ADVENTURE I - (7 GAMES)  
ADVENTURE II - TEXT GAMES,SELF BOOTING  
GAMES - VARIETY OF 22 GAMES  
TOOLKIT - AIDS TO PROGRAMMING, GRAPHICS, MUSIC & TECHNICAL DATA.  
GRAPHICS - 27 GRAPHICS PROGRAMS  
GRAB-BAG - 17 PROGRAMS,FILE SYSTEM,SCHEDA,TAX1040,ETC...

FOR A COMPLETE LISTING, SEND A SASE TO THE ABOVE ADDRESS REQUESTING SUCH A LIST.

**GORDON MEYER**  
"DO NOT STAMP SOFTWARE"  
2608 W. 6000 SOUTH  
ROY, UT 84067  
PHONE 801/773-7766

GORDEN MEYER OFFERS A NUMBER OF PROGRAMS FOR SALE OR TRADE.YOU MAY TRADE FOR PROGRAMS OR YOU MAY PAY A LOW FEE IF YOU HAVE NOTHING TO TRADE. ALSO, GORDON WORKED FOR COLECO PRIOR TO THE DROPPING OF THE ADAM AND HAS ACCESS TO A COMPLETE SET OF ADAM TECHNICAL MANUALS. IF YOU HAVE SPECIFIC QUESTIONS, YOU CAN

**R. A. SOFTWARE/FREWARE**  
BRENTWOOD BAPTIST CHURCH  
GORDON AT PEACOCK  
CHARLESTON HEIGHTS, SC 29405

THESE PEOPLE HAVE PROGRAMS OF A "RELIGIOUS" NATURE AVAILAIBLE AT A REASONABLY LOW PRICE. SEND A SASE TO THE ABOVE ADDRESS FOR COMPLETE LISTING AND INFORMATION.

**THE HOLY CITY AUG**  
C/O DAN PEASE  
12 BUDS AVENUE  
CHARLESTON HEIGHTS, SC 29405

THEY OFFER A PROGRAM CALLED "SCRIBBLEN" WHICH SAVES A LOW RES SCREEN FROM ANY PROGRAM. SEND \$1 PLUS SASE FOR LISTING.THEY ALSO ARE HAVING A CONTEST YOU MIGHT WANT TO CHECK INTO. REQUEST COMPLETE DETAILS AT THE ABOVE ADDRESS.

**DATACOM SUPER SYSTEM**  
PALM HARBOR, FL  
813/937-3608 OR 937-6829

THIS IS CHARGE BBS SYSTEM. THEY HAVE A GOOD SELECTION OF CP/M AND MS-DOS SOFTWARE. CALL ABOVE FOR COMPPLETE INFO AND APPLICATION. ALSO ASK ABOUT THEM SUPPLYING PROGRAMS ON DISK FOR YOU.

**INLAND EMPIRE COMPUTER GROUP BBS**  
COLTON, CALIFORNIA  
714/797-4745

THIS IS A FREE ACCESS BOARD WITH A SELECTION OF CP/M PROGRAMS. IT RUNS 300-1200 BAUD, NULL PARITY.

**ELLIAM ASSOCIATES**  
24000 BESEMER STREET  
WOODLAND HILLS, CA 91367

SEND FOR THE GENERAL FREE CATALOG, OR FOR THE COMPLETE LIST OF THOUSANDS OF PROGRAMS FOR \$7.50 THE AVERAGE COST PER DISK IS \$10.

# the ADAM<sup>TM</sup> Resource

P.O. BOX 90  
SEELYVILLE, INDIANA 47878



## SECTION ELEVEN (#11)

# ONLINE INFO

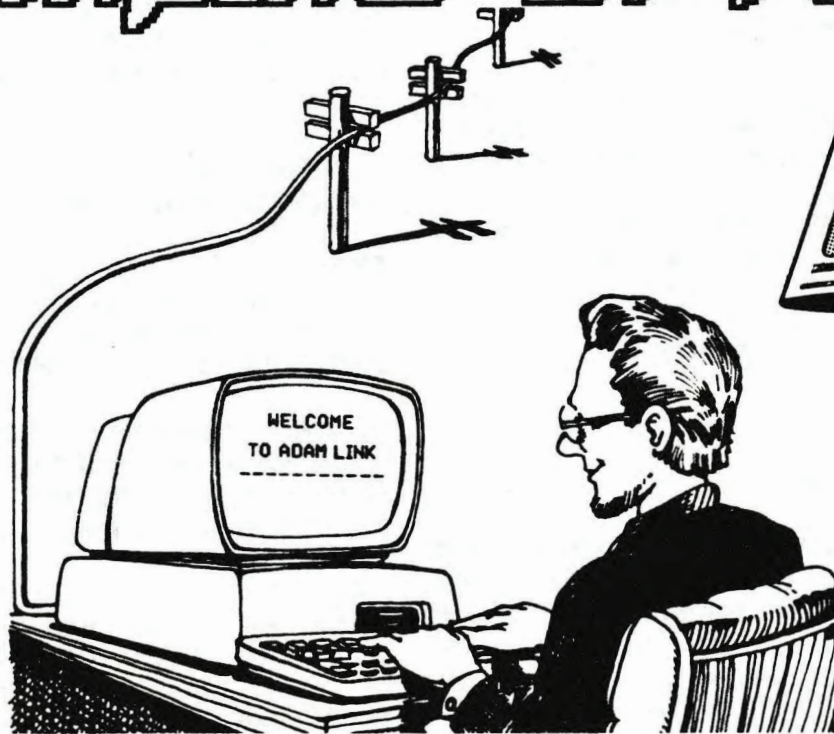

THIS SECTION WILL SHARE INFO SO YOU WILL GET THE MOST OUT OF YOUR MODEM. YOU WILL FIND THE FOLLOWING IN THIS SECTION:

GENERAL TIPS  
ADAM BBS'S  
ADAM INFO ON COMPU SERVE  
LISTINGS OF OTHER SERVICES  
LISTINGS OF OTHER BBS'S  
& MORE...

IF YOU ARE AWARE OF NEW ADAM BBS'S

WRITE TO US WITH ALL THE IMPORTANT INFO AT:

THE ADAM RESOURCE  
DEPT. 110 BOX 90  
SEELYVILLE, IN 47878

# \*\*ONLINE INFO\*\*

## NOTICE TO ALL MODEM OWNERS:



IF YOU PURCHASED ONE OF THE EARLIER MODEMS, YOU DO NOT HAVE THE NEW IMPROVED ADAMLINK II SOFTWARE. THIS PROGRAM IS A MUST FOR ALL MODEM OWNERS. (IT ALLOWS FOR UP-LOADING AND DOWN-LOADING OF ASCII FILES) CONTACT COLOECD AT THEIR 800 NUMBER. THE NEW SOFTWARE IS AVAILABLE FOR \$9.00 TO THOSE WHO BOUGHT THEIR MODEM BEFORE THE NEW VERSION WAS AVAILABLE. IF YOU BOUGHT A MODEM RECENTLY, CHANCES ARE YOU HAVE THE UPDATED COPY. IF IT IS THE UPDATED COPY, IT WILL PROBABLY HAVE ADAMLINK II ON THE LABEL.

### \*\*\*COMPUSERVE

### INFORMATION\*\*\*

IF YOU SUBSCRIBE TO COMPUSERVE, THERE ARE TWO ON-LINE AREAS FOR ADAM USERS. AFTER LOGGING-ON - GO FAN 200 (SECTION (6)ADAMANIA) FOR THE FAMILY COMPUTING FORUM, OR GO PCS 22 FOR THE CREATIVE COMPUTING FORUM (SECTION (8)EVEN ADAM)

BOTH FORUMS HAVE EXTENSIVE ADAM MESSAGE BASES AND (DL)DATA LIBRARIES WITH HELPFUL INFORMATION.

TO ACCESS COMPUSERVE YOU'LL NEED A STARTER KIT WHICH WILL GIVE YOU 5-HOURS OF TIME ON THE SYSTEM. IT IS POSSIBLE IN MOST LARGER CITIES TO ACCESS COMPUSERVE THROUGH A LOCAL NUMBER, SAVING LONG-DISTANCE CHARGES. COMPUSERVE IS PROBABLY THE BIGGEST SYSTEM IN OPERATION TODAY. YOU NEED TO DO A LOT OF READING AHEAD OF TIME TO GET THE MOST OUT OF THE SERVICE. AVERAGE COST IS \$6-\$8 PER HOUR.

## GENERAL TIPS FOR USING COMPUTER BULLETIN BOARDS

### 1. COMMUNICATIONS SETTINGS:

BOOT IN YOUR ADAMLINK PROGRAM AND SET YOUR PARAMETERS ACCORDING TO THE INSTRUCTIONS THAT PARTICULAR BOARD GIVES. IF YOU CANNOT ACCESS THE BOARD CORRECTLY, CHANCES ARE YOU HAVE MADE IMPROPER SETTINGS. GO BACK & START OVER IN SUCH A CASE, CHECK YOUR SETTINGS, MAKE NECESSARY CHANGES, THEN TRY AGAIN.

### 2. HOURS OF OPERATION

MOST BOARDS OPERATE 24 HOURS SO IT'S OK TO CALL ANYTIME. IF THE BOARD DOES NOT OPERATE 24-HOURS, YOU PROBABLY SHOULD NOT CALL THE BOARD ANY EARLIER THAN 6:00 PM IN ITS LOCAL TIME-ZONE. 8:00 PM WOULD BE EVEN SAFER.

### 3. OFF THE AIR:

IF A BOARD DOES NOT ANSWER AFTER TWO OR THREE RINGS, IT IS FOR SOME REASON OUT OF COMMISSION. POSSIBLY FOR GOOD OR FOR REPAIRS. HANG-UP AFTER 2-3 RINGS. MANY LONG-DISTANCE SERVICES NOW CHARGE YOU FOR A CALL EVEN IF IT IS NOT ANSWERED AFTER THREE RINGS. HANG-UP & SAVE MONEY!

### 4. WHO CAN YOU TALK TO?

YOU CAN TALK TO ANY BOARD USING YOUR ADAM. YOU SIMPLY NEED TO MAKE THE PROPER SETTINGS AND FOLLOW PROPER LOG-ON PROCEDURES FOR THAT PARTICULAR BOARD. IT IS ADVISED TO DOWNLOAD THE INSTRUCTIONS OFFERED WHEN YOU FIRST LOG-ON TO A SYSTEM. THAT WAY YOU WILL HAVE ALL THE INFO AT YOUR FINGERTIPS FOR FUTURE REFERENCE. REMEMBER...IF YOU ARE CONSTANTLY CALLING FOR THE "HELP" FILE YOU'RE GOING TO TAKE A LOT OF TIME AS WELL AS MONEY OUT OF YOUR POCKET.

### 5. BE CONSIDERATE

MOST SYSOPS WANT YOU TO USE THEIR SYSTEM...AND YOU OF COURSE NEED TO TAKE EXTRA TIME AT FIRST TO LEARN THAT PARTICULAR SYSTEM...HOWEVER...DON'T FORGET THAT OTHER PEOPLE WANT TO USE THE SYSTEM TOO! AND IF IT'S LONG DISTANCE...LOOK OUT! TIME FLIES WHEN YOU ARE ON-LINE, SO DON'T FORGET TO KEEP AN EYE ON YOUR TIME CONNECT DISPLAY AT THE BOTTOM OF THE SCREEN.

## ADAM OPERATED BULLETIN BOARDS

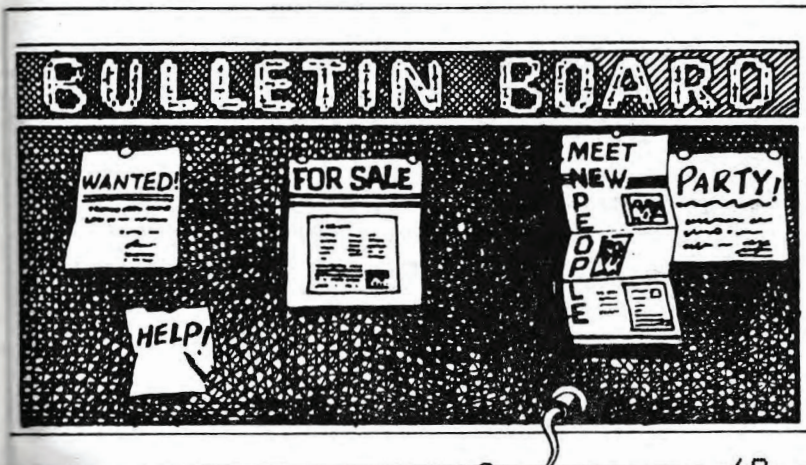

### \*\*DETROIT CO-OP BULLETIN BOARD- (313)342-3019

THIS BOARD IS EXTENSIVE AND USED BY MANY OTHER COMPUTERS AS WELL. WHEN YOU LOG-ON THE SYSTEM, ENTER "GUEST" WHEN IT ASKS FOR YOUR NAME THEN FOLLOW THE ONLINE INSTRUCTIONS FOR MEMBER SIGN-UP (NO FEES FOR THIS SYSTEM) TYPE "BBOARD4" AT THE \$ PROMPT, AND YOU WILL HAVE ACCESS TO THE ADAM SMARTBOARD. YOU CAN EITHER (R)EAD OR (S)END MESSAGES IN THIS SECTION. FILE UP- AND DOWN-LOADING SECTION IS ALSO AVAILABLE (TYPE "ACCESS" AT THE "\$" PROMPT AND (S)CAN TO SEE A LIST OF AVAILABLE PROGRAMS. FILE NAMES WHICH END WITH /ADM ARE FOR ADAM COMPUTERS) TYPE "HELP" AT ANY ANY PROMPT FOR FURTHER INSTRUCTIONS. TO LOG-OFF THE SYSTEM TYPE "BYE".



# \*\*ONLINE INFO\*\*



## \*\*TONY'S CORNER BBS - (313)754-1131

CALL THIS NUMBER-WHEN THE MODEM ANSWERS, HIT <RETURN>. THE SYSTEM WILL ASK YOUR NAME AND WILL ALLOW YOU TO SIGN-UP AS A REGULAR USER. IT WILL DISPLAY A SERIES OF BULLETINS AND THEN GIVE YOU A MENU OF OPTIONS. SELECT THE (M)ESSAGE OPTION, THEN (A)REA OPTION TO SEE A LIST OF MESSAGE AREAS. SELECT (4)ADAM AND YOU WILL BE ABLE TO (R)EAD THE VARIOUS ADAM RELATED MESSAGES POSTED THERE. ALL ARE ENCOURAGED TO PARTICIPATE BY LEAVING MESSAGES, ASKING QUESTIONS OR PROVIDING NEW INFO. UP AND DOWN-LOADING OF FILES IS AVAILABLE IN THE ADAM (F)ILES SECTION. BROWSE AROUND & ENTER A QUESTION MARK (?) AT MOST ANY PROMPT FOR HELP. BE SURE TO LOG-OFF THE SYSTEM PROPERLY BY USING THE (G)OODBYE COMMAND. NOTE: ANOTHER VERSION OF THE BULLETIN BOARD RUNS ON THIS SYSTEM FROM TIME TO TIME, AND THE COMMANDS ARE SLIGHTLY DIFFERENT, BUT BOTH VERSIONS HAVE ADAM SECTIONS.

## ADAM HOTLINE COMPUTER BBS - 818/761-1561

THIS BBS SYSTEM IS AN ADAM HOTLINE RUN BY THE PEOPLE AT VIDEO TAKE-OUT. THERE IS A \$9.00 LOG-ON FEE (PER MONTH) AND SPECIAL DISCOUNTS FOR LONG-DISTANCE CALLERS. THE BOARD IS IN OPERATION FROM 7 PM TO 7 AM DAILY. (NOTE THAT THOSE TIMES ARE PST). AT ALL OTHER TIMES, THIS NUMBER IS A VOICE LINE. YOU CAN WRITE TO VIDEO TAKE-OUT (ADDRESS IS IN RETAILERS SECTION) FOR MORE INFO, OR GIVE THEM A CALL DURING THE DAY TO GET THE SPECIFICS.

## \*\*THE ADAM INFO EXCHANGE- (404)445-8785

THIS IS A FREE ADAM OPERATED BBS, HOWEVER, TO GAIN ACCESS TO THE SYSTEM, YOU MUST HAVE AN ACCESS PASSWORD. TO OBTAIN YOUR PASSWORD AND LOG-ON INFO SIMPLY SEND A SASE TO:

AIX c/o SHERMAN MURDOCK  
RT. 9 BOX 36  
DALLAS, GA 30132

THERE ARE A NUMBER OF PUBLIC DOMAIN PROGRAMS ON THE SYSTEM FOR DOWN-LOADING. THIS CAN BE DONE WITH ADAMLINK 11.

## \*\*STEEL CITY BBS - 216/284-9081

THIS BBS RUNS 7 PM TO 7 AM, SEVEN DAYS A WEEK. CONTACT THE SYSOP, MIKE MITOCK AT THE ABOVE NUMBER. THERE ARE PLANS TO HAVE AN UPLOAD/DOWNLOAD SECTION ON THIS BBS IF THERE IS ENOUGH INTEREST. (LOCATED IN OHIO)

## \*\*THE TORONTO ADAM NET BBS - 416/536-9381

THIS IS TORONTO'S FIRST BBS FOR ADAM OWNERS. GIVE THEM A CALL FOR ALL THE DETAILS.

## \*\*INLAND EMPIRE COMPUTER GROUP BBS- 714/797-4745

THIS IS A FREE ACCESS BOARD BASED IN COLTON, CALIFORNIA. 300-1200 BAUD, NULL PARITY. THEY HAVE A SELECTION OF CP/M SOFTWARE AVAILABLE.

## \*\*PLANET EARTH BBS - 415/968-7728 SAN FRANCISCO AREA. OPERATES 24 HOURS. IT PROMISES TO BE "OUT OF THIS WORLD".

## \*\*DAKOM - 201/842-7644 NEW JERSEY AREA-OPERATES AFTER 6 PM EDT MONDAY, WEDNESDAY, THURSDAY, SATURDAY, SUNDAY.

## \*\*THE BREAD BOARD BBS - 501/442-8777

ARKANSAS -OPERATES 24 HOURS.

## \*\*CITADEL BBS -916/338-2352 24 HOUR BOARD

## \*\*WEBER STATE COLLEGE BBS - 801/626-7906

MONDAY-THURSDAY-7:30 PM TO 7:30 AM MST. 24-HOURS ON WEEKENDS AND HOLIDAYS.

## \*\*REMOTE ACCESS CP/M BBS - 213/325-0213

24-HOUR BOARD. SOUTHERN CALIFORNIA

## \*\*SEACOM-80 - 206/768-8879

24-HOUR BOARD. THE SEATTLE AREA ADAM USERS HANG OUT ON THIS BOARD. WHEN CALLING, LEAVE A MESSAGE FOR SYSOP THAT YOU ARE AN ADAM USER.



# **\*\*ONLINE INFO\*\***

## **BULLETIN BOARDS (ALL COMPUTERS)**

HERE IS A LISTING OF BBS'S ACROSS THE COUNTRY. THIS IS BY NO MEANS A COMPLETE LISTING, BUT THIS WILL GIVE YOU AN IDEA OF THE GREAT VARIETY OF BOARDS. THE INFO IN ( ) GIVES THE "SPECIAL" AREA OF INTEREST OF THAT BOARD. THEY ALL HAVE DIFFERENT LOG-ON PROCEDURES SO WE SUGGEST JUST CALLING AND FOLLOWING THEIR INSTRUCTIONS. (DON'T TRY TO CALL THEM ALL IN ONE NIGHT)

### **ABACUS-BY-PHONE**

(General interest, fee charged)

Anchorage, AK

(907) 278-4223

### **JOE'S COMPUTER**

(General)

Montgomery, AL

(205) 288-1100

### **ARIZONA BULLETIN BOARD**

(Items for sale, general)

Phoenix, AZ

(602) 957-4428

### **ARK-NET**

(General, part-time)

Little Rock, AR

(501) 372-0576

### **ORACLE BBS**

(Gay sex)

Hollywood, CA

(213) 980-5643

### **INTERACT**

(General, issues & discussion)

Sylmar, CA

(213) 367-0324

### **MINES OF MORIA**

(Games)

Aptos, CA

(408) 688-9629

### **CONFERENCE TREE**

(Conferencing)

Berkeley, CA

(408) 475-7101

### **PMS-GAMEBOARD**

(Role-playing games)

San Diego, CA

(619) 283-3574

### **PMS #1**

(General, BBS list, discussion)

Santee, CA

(619) 561-7277

### **GREENE MACHINE**

(General, BBS list,

conferencing)

Napa, CA

(707) 257-1101

### **PMS-IF-MAGAZINE**

(General, home video)

Anaheim, CA

(714) 772-8868

### **BULLET-80**

(Public domain software, games)

Sacramento, CA

(916) 971-1395

### **OLD COLORADO CITY**

### **ELECTRONIC COTTAGE**

(Writing, politics, general)

Colorado Springs, CO

(303) 632-3391

### **UFONET**

(Parapsychology, UFOs, other)

Golden, CO

(303) 278-4244

### **EDUCATION-80**

(Computers in schools)

Greenwich, CT

(203) 629-4375

### **FORUM-80**

(General)

Wilmington, DE

(302) 762-3170

### **ARMUDIC**

(General)

Washington, D.C.

(202) 276-8342

### **ALPHA**

(Writing, movies, polling)

Tampa, FL

(813) 969-0512

### **THE NOTEBOOK**

(Writing)

West Palm Beach, FL

(305) 686-4862

### **DR. D'S COCO CORNER**

(Color Computer)

Pensacola, FL

(904) 456-7195

### **ATLANTA COMPUTER SOCIETY**

(General, computers)

Atlanta, GA

(404) 636-6130

### **TRADE-80 MINI BBS**

(General)

Albany, GA

(912) 439-7440

### **CONFERENCE TREE**

(Conferencing)

Honolulu, HI

(808) 487-2001

### **WORD EXCHANGE**

(General)

Springfield, IL

(217) 753-4309

### **JAMS**

(General, public domain

software)

Lockport, IL

(815) 838-1020

### **AVC-COMMODORE**

### **BULLETIN BOARD**

(Commodore computers)

Indianapolis, IN

(317) 255-5435

### **APPLE MEDICAL**

### **BULLETIN BOARD**

(Medicine, part-time)

Iowa City, IA

(319) 353-6528

### **DICKENSON'S MOVIE**

### **GUIDE**

(Movie reviews)

Mission, KN

(913) 432-5544

### **TBBS**

(General)

Shreveport, LA

(318) 635-8660

### **RCP/M**

(Atari computers, CP/M)

Baton Rouge, LA

(504) 273 3116

### **PROGRAMMER'S**

### **ANONYMOUS**

(Osborne computers, general)

Gorham, ME

(207) 839-2337

### **GASNET**

(Space program)

Beltsville, MD

(301) 344-9156

### **TBBS**

(General)

Springfield, MA

(413) 733-1749

### **LAWRENCE GENERAL**

### **HOSPITAL**

(Medical)

Boston, MA

(617) 683-2119

**BARTON DATA LINE**

(General, BBS list)  
Ann Arbor, MI  
(313) 662-8303

**COMPUNET**

(General)  
Lansing, MI  
(517) 339-3367

**GRASS**

(Atari computers)  
Grand Rapids, MI  
(616) 241-1971

**THE JOB SYSTEM**

(Computer-related  
employment)  
Minneapolis, MN  
(612) 542-9597

**LAWSIG**

(Computer-related law)  
Minneapolis, MN  
(612) 872-2352

**CBBS**

(Christensen & Suess)  
Kansas City, MO  
(312) 546-8086

**DIALOG**

Dialog Information Services,  
Inc.  
3460 Hillview Ave.  
Palo Alto, CA 94304  
(800) 227-1927  
(800) 982-5838

**HAM BBS**

(Ham radio, games)  
Independence, MO  
(816) 833-3427

**SOUTHERN BULLET**

(General)  
Hattiesburg, MS  
(601) 264-2361

**ABBS**

(General, CP/M)  
Omaha, NE  
(402) 292-9598

**MAGAZINE-80**

(Writing, TRS computers)  
Peterborough, NH  
(603) 924-7920

**LIMERICKS**

(Limericks, trivia)  
New Brunswick, NJ  
(201) 572-0617

**ED GELB'S DATA BASE**

(Real Estate, BBS lists)  
Wayne, NJ  
(201) 694-7425

**PHOTO-80**

(Photography)  
Haledon, NJ  
(201) 790-6795

**PMS—MCGRAW-HILL BOOK  
COMPANY**

(Mail, book catalogue shopping)  
New York, NY  
(212) 512-2488

**TICKERSCREEN**

(Stock market)  
New York, NY  
(212) 986-1660

**LICA**

(General, computer)  
Bethpage, NY  
(516) 561-6590

**PC-BBS**

(General, computers)  
Charlotte, NC  
(704) 365-4311

**PMS-RAUG**

(General)  
Akron, OH  
(216) 867-7463

**INDEPENDENT BBS**

(General)  
Toledo, OH  
(419) 729-4221

**TBBS**

(General, adult)  
Tulsa, OK  
(918) 749-0059

**BIT BUCKET BBS**

(General)  
Portland, OR  
(503) 761-6345

**RCP/M**

(Atari computers)  
Cheltenham, PA  
(215) 836-5116

**FORUM-80**

(General, BBS list)  
Memphis, TN  
(901) 276 8196

**TBBS**

(General)  
Austin, TX  
(512) 385-1102

**THE AUSTIN PARTY BOARD**

(General, adult)  
Austin, TX  
(512) 442-1116

**THE ARMADILLO**

(General, Atari computers)  
Austin, TX  
(512) 837-2003

**THE TEXAS LEPRECHAUN**

(General)  
Austin, TX  
(512) 288-2114

**TBBS #1**

(General, computers)  
Austin, TX  
(512) 385-1102

**THE DINER**

(General interest)  
Austin, TX  
(512) 443-3084

**TEXAS T-NET**

(General)  
Austin, TX  
(512) 345-8290

**BURG BOARD**

(General, fiction games)  
Amarillo, TX  
(806) 374-9711

**TBBS**

(General, computer)  
San Angelo, TX  
(915) 942-8035

**CBBS AMRAD**

(Ham radio, broad range of  
technical information)  
McLean, VA

(703) 734-1387

**DIAL-YOUR-MATCH #32**

(Matchmaking)  
Newport News, VA  
(804) 838-3973

**MAILBOARD 82.1**

(General, BBS list)  
Seattle, WA  
(206) 527-0897

**TBBS**

(General, BBS list)  
Comet, WV  
(304) 273-4136

**CANOPUS**

(General, teenagers)  
Greenfield, WI  
(414) 281-0545

**PMS-CENTURY 23**

(General)  
Las Vegas, NV  
(702) 878-9106

**DATABASE & SERVICE LISTING****BRS**

Bibliographic Retrieval Services  
1200 Rte. 7  
Latham, NY 12110  
(800) 833-4707

**BRS/AFTER DARK**

Bibliographic Retrieval Services  
1200 Rte. 7  
Latham, NY 12110  
(800) 833-4707

**C.A.R.O.L.**

Computer Assisted Research  
On Line  
Bob Sherman  
1166 N.E. 182 St.

North Miami Beach, FL 33160  
(305) 944-2111

**CHASE ECONOMETRICS**

Chase Econometrics/Interactive  
Data Corporation  
486 Totten Pond Rd.  
Waltham, MA 02154  
(617) 890-1234

**CITISHARE CORPORATION**

850 3rd Ave.  
New York, NY 10043  
(212) 572-9605

**COLLECTOR'S DATA SERVICE**

420 West Mercer  
Seattle, WA 98119  
(800) 435-0100  
(206) 281-7273 in Washington

**COMPUSERVE**

Consumer Information Service  
5000 Arlington Center Blvd.  
P. O. Box 20212  
Columbus, OH 43220  
(800) 848-8199  
in Ohio  
(614) 457-0802

**DELPHI**

General Videotex Corporation  
3 Blackstone St.  
Cambridge, MA 02139  
(617) 491-3393

**DOW JONES****NEWS/RETRIEVAL**

Dow Jones and Company, Inc.  
P. O. Box 300  
Princeton, NJ 08540  
(800) 257-5114

(609) 452-1511 in New Jersey

**E-COM**

United States Postal Service  
call your local Post Office

**EDNET**

National Education  
Corporation  
315 Post Rd.

Westport, CT 06880  
(203) 227-0891

**EIES**

Electronic Information  
Exchange System  
Computerized Conferencing  
and Communications Center  
323 High St.

Newark, NJ 07102

(201) 645-5221

**ELECTRONIC UNIVERSITY**

TeleLearning Systems, Inc.  
505 Beach St.

San Francisco, CA 94133  
(415) 928-2800

**THE ELECTRIC PAGES**

P. O. Box 2550  
Austin, TX 78768  
(512) 472-6432

**THE INFORMATION BANK**

New York Times Information  
Service

1719A—Route 10  
Parsippany, NJ 07054

(201) 539-5850

(212) 683-2208 in New York

(793) 243-7220 in Washington,  
D.C.

(312) 236-6800 in Chicago

(415) 522-2600 in San Francisco

(213) 852-7003 in Los Angeles

(713) 965-9371 in Houston

(416) 598-5250 in Toronto

**KNOWLEDGE INDEX**

Dialog Information Services,  
Inc.

3460 Hillview Ave.

Palo Alto, CA 94304

(800) 227-5510

(415) 858-3796 in California

(800) 227-1927 (Dialog)

**THE ELECTRONIC EDITION**

Official Airlines Guides, Inc.  
2000 Clearwater Dr.  
Oak Brook, IL 60521  
(312) 654-6000

**HAM RADIO NETWORK**

Chesapeake Microcomputer  
Club

Joe Kasser, President

11532 Stewart Ln.

Silver Spring, MD 20904

**ITT DIALCOM**

ITT Dialcom, Inc.

1109 Spring St.

Silver Spring, MD 20910

(301) 588-1572

**MCI MAIL**

(800) 323-7751 to register by  
computer

(800) MCI-2255 for information

**NEWSNET**

945 Haverford Rd.

Bryn Mawr, PA 19010

(800) 345-1301

(215) 527-8030

**NITE-LINE**

National Computer Network

1929 Harlem Ave.

Chicago, IL 60635

(312) 622-6666

**ORBIT**

SDC Information Services

2500 Colorado Ave.

Santa Monica, CA 90406

(800) 421-7229

(800) 352-6689 in California

**PARTICIPATE**

Participation Systems, Inc.

43 Myrtle Ter.

Winchester, MA 01890

(617) 729-1976

**PLATO**

Control Data Corporation

Call the CDC office nearest  
you, or

Minneapolis, MN

(800) 328-1109

**SEARCHMART**

Searchmart Corporation

636 U. S. Highway 1, Suite 210

North Palm Beach, FL 33408

(305) 845-2996

**THE SOURCE**

Source Telecomputing Corporation  
1616 Anderson Rd.  
McLean, VA 22102  
(800) 336-3366  
(703) 734-7540 in Virginia

**TELENET**  
GTE Telenet  
8229 Boone Blvd.  
Vienna, VA 22180  
(703) 827-9565  
(800) 336-0437  
(800) 572-0408 in Virginia

**TYMNET**

Tymshare, Inc.  
20705 Valley Green Dr.  
Cupertino, CA 95014  
(408) 446-6236  
(800) 336-0149 in the East  
(800) 323-7389 in the West

**WESTERN UNION**  
**EASYLINK**  
(800) 336-3797 ext. 108  
(703) 448-8877 ext. 108 in Virginia

## PUBLICATIONS & DIRECTORIES OF ON-LINE SERVICES

**COMPUTER-READABLE DATABASES**

American Society for Information Science  
1010 16th St. NW  
Washington, D.C. 20036  
(202) 659-3644

**COMPUTER-READABLE DATABASES:****A DIRECTORY AND DATA SOURCEBOOK**

Knowledge Industry Publications, Inc.  
701 Winchester Ave.  
White Plains, NY 10604  
(914) 328-9157

**DATACAST**

Wireless Digital, Inc.  
345 Sweet Rd.  
Woodside, CA 94062  
(415) 851-2814

**DATAPRO DIRECTORY OF ON-LINE SERVICES**

Datapro Research Corporation  
1805 Underwood Blvd.  
Delran, NJ 08075  
(609) 764-0100

**DIRECTORY OF FEDERAL STATISTICAL DATA FILES**

National Technical Information Service  
5285 Port Royal Rd.  
Springfield, VA 22161  
(804) 487-4600

**DIRECTORY OF ONLINE DATABASES**

Cuadra Associates, Inc.  
2001 Wilshire Blvd., Suite 305  
Santa Monica, CA 90403  
(213) 829-9972

**ELECTRONIC MAIL & MESSAGE SYSTEMS (EMMS)**

International Resource Development  
30 High St.  
Norwalk, CT 06851  
(203) 866-6914

**ENCYCLOPEDIA OF INFORMATION SYSTEMS AND SERVICES**

Gale Research Company  
Book Tower  
Detroit, MI 48226  
(313) 961-2242

**INFORMATION INDUSTRY MARKETPLACE**

R.R. Bowker and Company  
1180 Sixth Ave.  
New York, NY 10036  
(212) 764-5100

**INFORMATION SOURCES**

Information Industry Association  
316 Pennsylvania Ave, SE  
Suite 400  
Washington, DC 20003  
(202) 544-1969

**MICROCOMPUTER INFORMATION SUPPORT TOOLS (MIST)**

Peter and Trudy Johnson-Lenz  
695 Fifth St.  
Lake Oswego, OR 97034  
(503) 635-2615

**ONLINE and DATABASE Online, Inc.**

11 Tannery Ln.  
Weston, CT 06883  
(203) 227-8466

**THE ON-LINE COMPUTER TELEPHONE DIRECTORY**

J. A. Cambron Company, Inc.  
P. O. Box 10005  
Kansas City, MO 64111  
(816) 756-1847  
CompuServe 70040.414

**OTHER NETWORKS**

P. O. Box 14066  
Philadelphia, PA 19123

**SPACE RESEARCH NEWSLETTER**

Steven K. Moyer  
P. O. Box 803  
State College, PA 16801  
(814) 238-2279  
Delphi: SPACEMAN  
**VIDEOPRINT**  
International Resource Development  
30 High St.  
Norwalk, CT 06851  
(203) 866-6914

## ON-LINE BOOKS

*The Complete Handbook of Personal Computer Communications*  
by Alfred Glossbrenner  
St. Martin's Press  
New York, NY  
1983

*The Computer Phone Book*  
by Mike Cane  
New American Library, 1983  
(Updates available from: Mike Cane  
The Computer Phone Book  
175 Fifth Ave., Suite 3371  
New York, NY 10010)

*Hooking In*  
by Tom Beeston & Tom Tucker  
ComputerFood Press  
Westlake Village, CA  
1983

*How to Create Your Own Computer Bulletin Board*  
by Lary L. Myers  
TAB Books, Inc.  
Blue Ridge Summit, PA  
1983

*The Network Nation: Human Communication via Computer*  
by Murray Turoff and Starr Roxanne Hiltz  
Addison-Wesley  
Reading, MA  
1978

*The Network Revolution: Confessions of a Computer Scientist*  
by Jacques Vallee  
And/Or Press, Inc.  
Berkeley, CA  
1982

USE THIS PAGE FOR NOTES...WHEN YOU COLLECT A FEW IMPORTANT FACTS...WRITE TO US AT THE ADAM RESOURCE..WE WANT TO HEAR FROM YOU!!!



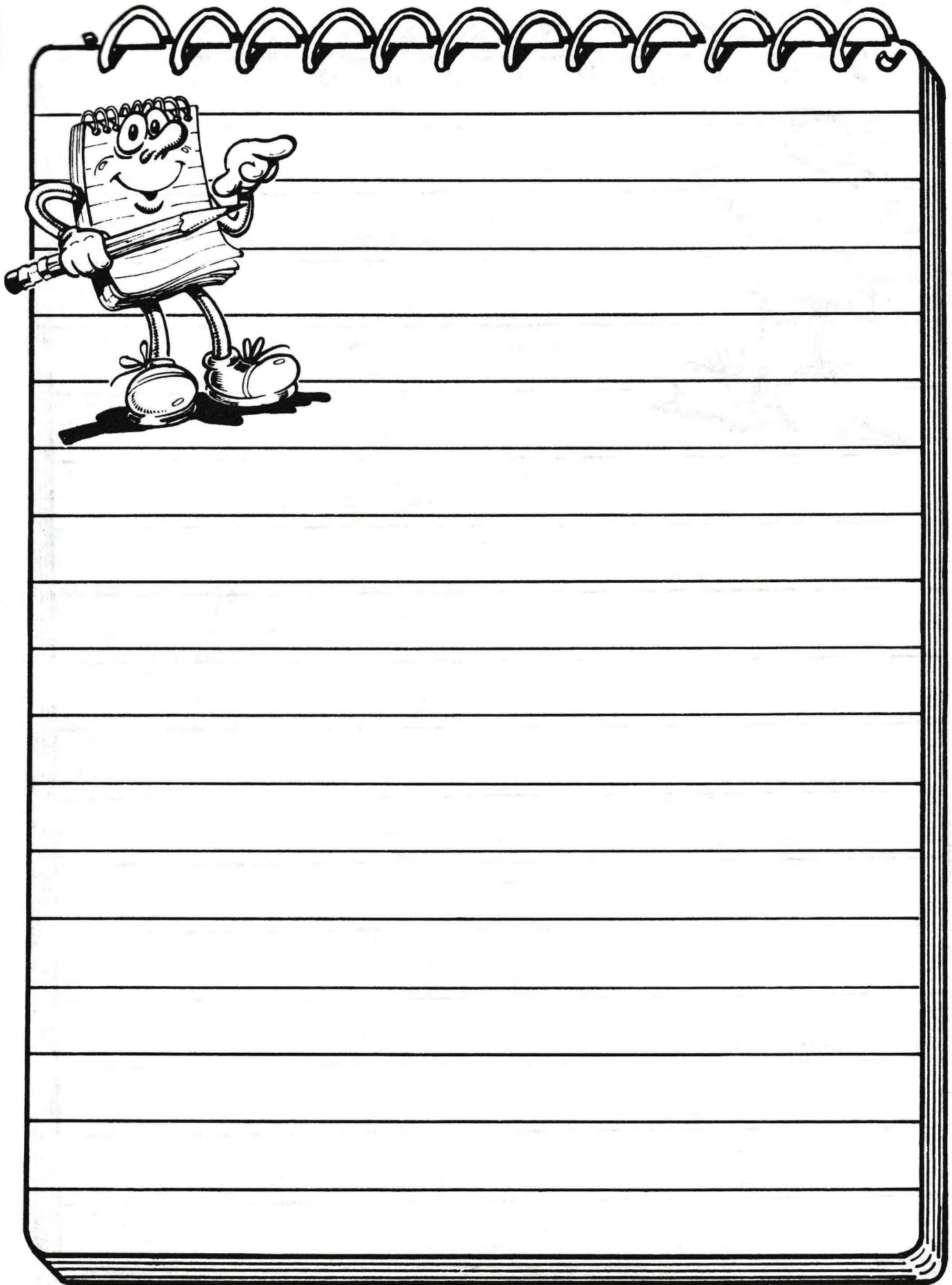

**WATCH FOR THE**

**1986**

**ADAM RESOURCE**

**DIRECTORY**



**THE NEXT EDITION**

**WILL INCLUDE...**

**SOFTWARE REVIEWS**

**USER GROUP NEWS**

**MORE GROUPS**

**MORE TIPS**

**MORE USERS**

**MORE EVERYTHING!**

**EARLY SPRING 1986**

IN THIS DIRECTORY YOU'LL FIND...

**EVERYTHING**  
FOR THE  
**ADAM**<sup>TM</sup> THE **COLECOVISION**<sup>®</sup>  
FAMILY COMPUTER SYSTEM

---

1. SOFTWARE
2. HARDWARE
3. RETAILERS
4. PUBLICATIONS
5. USER GROUP INFO
6. USER LISTINGS
7. SERVICE INFO
8. TIPS
9. AD-SECTION
10. PUBLIC DOMAIN
11. ONLINE INFO